

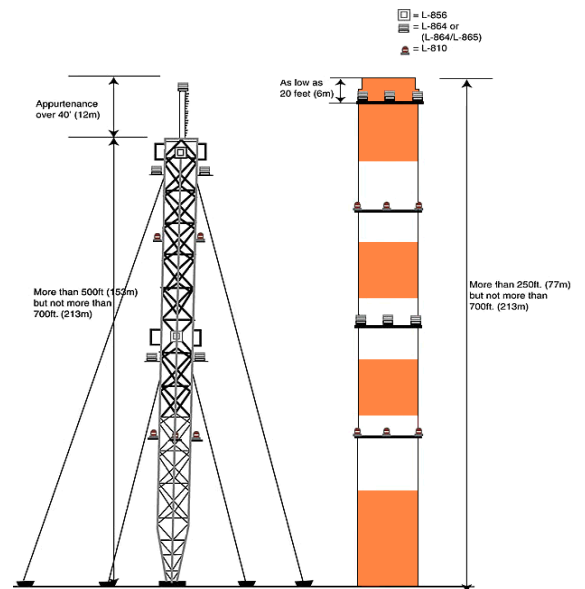

Obstruction Marking and Lighting

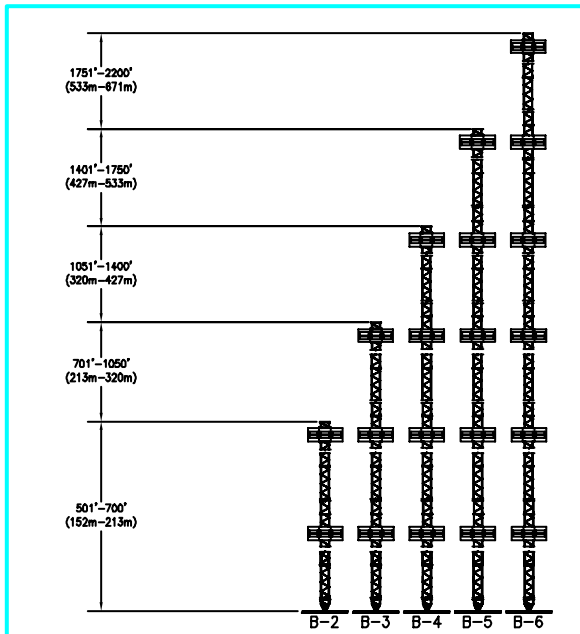
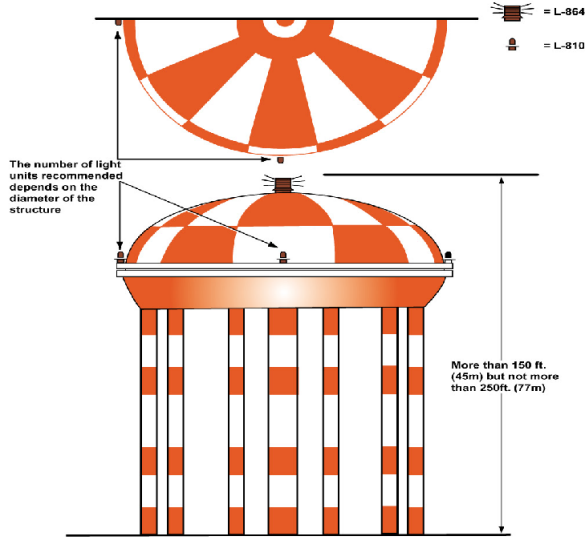

Subject: CHANGE 2 TO OBSTRUCTION
MARKING AND LIGHTING

Date: 2/1/07
Initiated by: AJR-33

AC No.: 70/7460-1K
Change: 2

1. PURPOSE. This change amends the Federal Aviation Administration's standards for marking and lighting structures to promote aviation safety. The change number and date of the change material are located at the top of the page.
2. EFFECTIVE DATE. This change is effective February 1, 2007.
3. EXPLANATION OF CHANGES.
 - a. Table of Contents. Change pages i through iii.
 - b. Page 1. Paragraph 1. **Reporting Requirements**. Incorporated the word "Title" in reference to the 14 Code of Federal Regulations (14 CFR part 77). FAA Regional Air Traffic Division office to read Obstruction Evaluation service (OES). FAA website to read <http://oeaaa.faa.gov>.
 - c. Page 1. Paragraph 4. **Supplemental Notice Requirement** (subpart b). FAA Regional Air Traffic Division office to read OES.
 - d. Page 1. Paragraph 5. **Modifications and Deviations** (subpart a). FAA Regional Air Traffic Division office to read OES.
 - e. Page 1. Paragraph 5. **Modifications and Deviations** (subpart c). FAA Regional office to read OES.
 - f. Page 2. Paragraph 5. **Modifications and Deviations** (subpart d). Removed period to create one sentence.
 - g. Page 2. Paragraph 7. **Metric Units**. And to read however.
 - h. Page 3. Paragraph 23. **Light Failure Notification** (subpart b). Nearest to read appropriate. FAA's website to read web. Website www.faa.gov/ats/ata/ata400 to read <http://www.afss.com>.
 - i. Page 4. Paragraph 24. **Notification of Restoration**. Removed AFSS.
 - j. Page 5. Paragraph 32. **Paint Standards**. Removed a comma after "Since".
 - k. Page 5. Paragraph 33. **Paint Patterns** (subpart d. **Alternate Bands**). Removed number 6. Number 7 to read number 6.
 - l. Page 9. Paragraph 41. **Standards**. TASC to read OTS. SVC-121.23 to read M-30.

- m. Page 14. Paragraph 55. **Wind Turbine Structures.** Removed. The paragraph numbers that follow have been changed accordingly.
- n. Page 18. Paragraph 65. **Wind Turbine Structures.** Removed. The paragraph numbers that follow have been changed accordingly.
- o. Page 20. Paragraph 77. **Radio and Television Towers and Similar Skeletal Structures.** Excluding to read including.
- p. Page 23. Paragraph 85. **Wind Turbine Structures.** Removed. The paragraph number that follows has been changed accordingly.
- q. Page 33-34. Chapter 13. **Marking and Lighting Wind Turbine Farms.** Added.
- r. Page A1-3. Appendix 1. Verbiage removed under first structure.



Nancy B. Kalinowski

Director, System Operations Airspace and Aeronautical Information Management

PAGE CONTROL CHART

AC 70/7460-1K CHG 2

Remove Pages	Dated	Insert Pages	Dated
i through iii	8/1/00	i through iii	1/1/07
1-5	8/1/00	1-5	1/1/07
9	3/1/00	9	1/1/07
14	3/1/00	14	1/1/07
18-34	3/1/00	18-34	1/1/07
A1-3	8/1/00	A1-3	1/1/07

TABLE OF CONTENTS

CHAPTER 1. ADMINISTRATIVE AND GENERAL PROCEDURES

1. REPORTING REQUIREMENTS	1
2. PRECONSTRUCTION NOTICE.....	1
3. FAA ACKNOWLEDGEMENT	1
4. SUPPLEMENTAL NOTICE REQUIREMENT	1
5. MODIFICATIONS AND DEVIATIONS.....	1
6. ADDITIONAL NOTIFICATION	2
7. METRIC UNITS	2

CHAPTER 2. GENERAL

20. STRUCTURES TO BE MARKED AND LIGHTED	3
21. GUYED STRUCTURES.....	3
22. MARKING AND LIGHTING EQUIPMENT	3
23. LIGHT FAILURE NOTIFICATION	3
24. NOTIFICATION OF RESTORATION	4
25. FCC REQUIREMENT	4

CHAPTER 3. MARKING GUIDELINES

30. PURPOSE	5
31. PAINT COLORS.....	5
32. PAINT STANDARDS	5
33. PAINT PATTERNS	5
34. MARKERS.....	6
35. UNUSUAL COMPLEXITIES.....	7
36. OMISSION OR ALTERNATIVES TO MARKING.....	7

CHAPTER 4. LIGHTING GUIDELINE

40. PURPOSE	9
41. STANDARDS.....	9
42. LIGHTING SYSTEMS.....	9
43. CATENARY LIGHTING	10
44. INSPECTION, REPAIR AND MAINTENANCE	10
45. NONSTANDARD LIGHTS.....	10
46. PLACEMENT FACTORS.....	10
47. MONITORING OBSTRUCTION LIGHTS	11
48. ICE SHIELDS.....	11
49. DISTRACTION.....	11

CHAPTER 5. RED OBSTRUCTION LIGHT SYSTEM

50. PURPOSE	13
51. STANDARDS.....	13
52. CONTROL DEVICE	13
53. POLES, TOWERS, AND SIMILAR SKELETAL STRUCTURES	13
54. CHIMNEYS, FLARE STACKS, AND SIMILAR SOLID STRUCTURES.....	14
55. GROUP OF OBSTRUCTIONS.....	14
56. ALTERNATE METHOD OF DISPLAYING OBSTRUCTION LIGHTS	15
57. PROMINENT BUILDINGS, BRIDGES, AND SIMILAR EXTENSIVE OBSTRUCTIONS.....	15

CHAPTER 6. MEDIUM INTENSITY FLASHING WHITE OBSTRUCTION LIGHT SYSTEMS

60. PURPOSE	17
61. STANDARDS.....	17
62. RADIO AND TELEVISION TOWERS AND SIMILAR SKELETAL STRUCTURES.....	17
63. CONTROL DEVICE	17
64. CHIMNEYS, FLARE STACKS, AND SIMILAR SOLID STRUCTURES.....	18
65. GROUP OF OBSTRUCTIONS.....	18
66. SPECIAL CASES.....	18
67. PROMINENT BUILDINGS AND SIMILAR EXTENSIVE OBSTRUCTIONS	18

CHAPTER 7. HIGH INTENSITY FLASHING WHITE OBSTRUCTION LIGHT SYSTEMS

70. PURPOSE	19
71. STANDARDS.....	19
72. CONTROL DEVICE	19
73. UNITS PER LEVEL	19
74. INSTALLATION GUIDANCE.....	19
75. ANTENNA OR SIMILAR APPURTENANCE LIGHT	20
76. CHIMNEYS, FLARE STACKS, AND SIMILAR SOLID STRUCTURES.....	20
77. RADIO AND TELEVISION TOWERS AND SIMILAR SKELETAL STRUCTURES.....	20
78. HYPERBOLIC COOLING TOWERS.....	20
79. PROMINENT BUILDINGS AND SIMILAR EXTENSIVE OBSTRUCTIONS	21

CHAPTER 8. DUAL LIGHTING WITH RED/MEDIUM INTENSITY FLASHING WHITE SYSTEMS

80. PURPOSE	23
81. INSTALLATION	23
82. OPERATION.....	23
83. CONTROL DEVICE	23
84. ANTENNA OR SIMILAR APPURTENANCE LIGHT	23
85. OMISSION OF MARKING	23

CHAPTER 9. DUAL LIGHTING WITH RED/HIGH INTENSITY FLASHING WHITE SYSTEMS

90. PURPOSE	25
91. INSTALLATION	25
92. OPERATION.....	25
93. CONTROL DEVICE	25
94. ANTENNA OR SIMILAR APPURTENANCE LIGHT	25
95. OMISSION OF MARKING	25

CHAPTER 10. MARKING AND LIGHTING OF CATENARY AND CATENARY SUPPORT STRUCTURES

100. PURPOSE	27
101. CATENARY MARKING STANDARDS	27
102. CATENARY LIGHTING STANDARDS.....	27
103. CONTROL DEVICE	28
104. AREA SURROUNDING CATENARY SUPPORT STRUCTURES.....	28
105. THREE OR MORE CATENARY SUPPORT STRUCTURES	28

CHAPTER 11. MARKING AND LIGHTING MOORED BALLOONS AND KITES

110. PURPOSE	29
111. STANDARDS.....	29
112. MARKING.....	29
113. PURPOSE	29
114. OPERATIONAL CHARACTERISTICS.....	29

CHAPTER 12. MARKING AND LIGHTING EQUIPMENT AND INFORMATION

120. PURPOSE	31
121. PAINT STANDARD	31
122. AVAILABILITY OF SPECIFICATIONS	31
123. LIGHTS AND ASSOCIATED EQUIPMENT.....	31
124. AVAILABILITY	32

CHAPTER 13. MARKING AND LIGHTING WIND TURBINE FARMS

130. PURPOSE	33
131. GENERAL STANDARDS	33
132. WIND TURBINE CONFIGURATIONS.....	33
133. MARKING STANDARDS.....	33
134. LIGHTING STANDARDS	33

APPENDIX 1: SPECIFICATIONS FOR OBSTRUCTION LIGHTING EQUIPMENT CLASSIFICATION

APPENDIX	A1-2
----------------	------

APPENDIX 2. MISCELLANEOUS

1. RATIONALE FOR OBSTRUCTION LIGHT INTENSITIES	A2-1
2. DISTANCE VERSUS INTENSITIES.	A2-1
3. CONCLUSION.....	A2-1
4. DEFINITIONS.....	A2-1
5. LIGHTING SYSTEM CONFIGURATION.	A2-2

CHAPTER 1. ADMINISTRATIVE AND GENERAL PROCEDURES

1. REPORTING REQUIREMENTS

A sponsor proposing any type of construction or alteration of a structure that may affect the National Airspace System (NAS) is required under the provisions of Title 14 Code of Federal Regulations (14 CFR part 77) to notify the FAA by completing the Notice of Proposed Construction or Alteration form (FAA Form 7460-1). The form should be sent to the Obstruction Evaluation service (OES). Copies of FAA Form 7460-1 may be obtained from OES, Airports District Office or FAA Website at <http://oeaaa.faa.gov>.

2. PRECONSTRUCTION NOTICE

The notice must be submitted:

a. At least 30 days prior to the date of proposed construction or alteration is to begin.

b. On or before the date an application for a construction permit is filed with the Federal Communications Commission (FCC). (The FCC advises its applicants to file with the FAA well in advance of the 30-day period in order to expedite FCC processing.)

3. FAA ACKNOWLEDGEMENT

The FAA will acknowledge, in writing, receipt of each FAA Form 7460-1 notice received.

4. SUPPLEMENTAL NOTICE REQUIREMENT

a. If required, the FAA will include a FAA Form 7460-2, Notice of Actual Construction or Alteration, with a determination.

b. FAA Form 7460-2 Part 1 is to be completed and sent to the FAA at least 48 hours prior to starting the actual construction or alteration of a structure. Additionally, Part 2 shall be submitted no later than 5 days after the structure has reached its greatest height. The form should be sent to the OES.

c. In addition, supplemental notice shall be submitted upon abandonment of construction.

d. Letters are acceptable in cases where the construction/alteration is temporary or a proposal is abandoned. This notification process is designed to permit the FAA the necessary time to change affected procedures and/or minimum flight altitudes, and to otherwise alert airmen of the structure's presence.

Note-
NOTIFICATION AS REQUIRED IN THE DETERMINATION IS
CRITICAL TO AVIATION SAFETY.

5. MODIFICATIONS AND DEVIATIONS

a. Requests for modification or deviation from the standards outlined in this AC must be submitted to the OES. The sponsor is responsible for adhering to approved marking and/or lighting limitations, and/or recommendations given, and should notify the FAA and FCC (for those structures regulated by the FCC) prior to removal of marking and/or lighting. A request received after a determination is issued may require a new study and could result in a new determination.

b. *Modifications.* Modifications will be based on whether or not they impact aviation safety. Examples of modifications that may be considered:

1. *Marking and/or Lighting Only a Portion of an Object.* The object may be so located with respect to other objects or terrain that only a portion of it needs to be marked or lighted.

2. *No Marking and/or Lighting.* The object may be so located with respect to other objects or terrain, removed from the general flow of air traffic, or may be so conspicuous by its shape, size, or color that marking or lighting would serve no useful purpose.

3. *Voluntary Marking and/or Lighting.* The object may be so located with respect to other objects or terrain that the sponsor feels increased conspicuity would better serve aviation safety. Sponsors who desire to voluntarily mark and/or light their structure should request the proper marking and/or lighting from the FAA to ensure no aviation safety issues are impacted.

4. *Marking or Lighting an Object in Accordance with the Standards for an Object of Greater Height or Size.* The object may present such an extraordinary hazard potential that higher standards may be recommended for increased conspicuity to ensure the safety to air navigation.

c. *Deviations.* The OES conducts an aeronautical study of the proposed deviation(s) and forwards its recommendation to FAA headquarters in Washington, DC, for final approval. Examples of deviations that may be considered:

1. Colors of objects.
2. Dimensions of color bands or rectangles.
3. Colors/types of lights.
4. Basic signals and intensity of lighting.

5. Night/day lighting combinations.

6. Flash rate.

d. The FAA strongly recommends that owners become familiar with the different types of lighting systems and to specifically request the type of lighting system desired when submitting FAA Form 7460-1. (This request should be noted in "item 2.D" of the FAA form.) Information on these systems can be found in Chapter 12, Table 4 of this AC. While the FAA will make every effort to accommodate the structure sponsor's request, sponsors should also request information from system manufacturers in order to determine which system best meets their needs based on purpose, installation, and maintenance costs.

6. ADDITIONAL NOTIFICATION

Sponsors are reminded that any change to the submitted information on which the FAA has based its determination, including modification, deviation or optional upgrade to white lighting on structures which are regulated by the FCC, must also be filed with the FCC prior to making the change for proper

authorization and annotations of obstruction marking and lighting. These structures will be subject to inspection and enforcement of marking and lighting requirements by the FCC. FCC Forms and Bulletins can be obtained from the FCC's National Call Center at 1-888-CALL-FCC (1-888-225-5322). Upon completion of the actual change, notify the Aeronautical Charting office at:

NOAA/NOS
Aeronautical Charting Division
Station 5601, N/ACC113
1305 East-West Highway
Silver Spring, MD 20910-3233

7. METRIC UNITS

To promote an orderly transition to metric units, sponsors should include both English and metric (SI units) dimensions. The metric conversions may not be exact equivalents, however, until there is an official changeover to the metric system, the English dimensions will govern.

CHAPTER 2. GENERAL

20. STRUCTURES TO BE MARKED AND LIGHTED

Any temporary or permanent structure, including all appurtenances, that exceeds an overall height of 200 feet (61m) above ground level (AGL) or exceeds any obstruction standard contained in 14 CFR part 77, should normally be marked and/or lighted. However, an FAA aeronautical study may reveal that the absence of marking and/or lighting will not impair aviation safety. Conversely, the object may present such an extraordinary hazard potential that higher standards may be recommended for increased conspicuity to ensure safety to air navigation. Normally outside commercial lighting is not considered sufficient reason to omit recommended marking and/or lighting. Recommendations on marking and/or lighting structures can vary depending on terrain features, weather patterns, geographic location, and in the case of wind turbines, number of structures and overall layout of design. The FAA may also recommend marking and/or lighting a structure that does not exceed 200 (61m) feet AGL or 14 CFR part 77 standards because of its particular location.

21. GUYED STRUCTURES

The guys of a 2,000-foot (610m) skeletal tower are anchored from 1,600 feet (488m) to 2,000 feet (610m) from the base of the structure. This places a portion of the guys 1,500 feet (458m) from the tower at a height of between 125 feet (38m) to 500 feet (153m) AGL. 14 CFR part 91, section 119, requires pilots, when operating over other than congested areas, to remain at least 500 feet (153m) from man-made structures. Therefore, the tower must be cleared by 2,000 feet (610m) horizontally to avoid all guy wires. Properly maintained marking and lighting are important for increased conspicuity since the guys of a structure are difficult to see until aircraft are dangerously close.

22. MARKING AND LIGHTING EQUIPMENT

Considerable effort and research have been expended in determining the minimum marking and lighting systems or quality of materials that will produce an acceptable level of safety to air navigation. The FAA will recommend the use of only those marking and lighting systems that meet established technical standards. While additional lights may be desirable

to identify an obstruction to air navigation and may, on occasion be recommended, the FAA will recommend minimum standards in the interest of safety, economy, and related concerns. Therefore, to provide an adequate level of safety, obstruction lighting systems should be installed, operated, and maintained in accordance with the recommended standards herein.

23. LIGHT FAILURE NOTIFICATION

a. Sponsors should keep in mind that conspicuity is achieved only when all recommended lights are working. Partial equipment outages decrease the margin of safety. Any outage should be corrected as soon as possible. Failure of a steady burning side or intermediate light should be corrected as soon as possible, but notification is not required.

b. Any failure or malfunction that lasts more than thirty (30) minutes and affects a top light or flashing obstruction light, regardless of its position, should be reported immediately to the appropriate flight service station (FSS) so a Notice to Airmen (NOTAM) can be issued. Toll-free numbers for FSS are listed in most telephone books or on the web at <http://www.afss.com>. This report should contain the following information:

1. Name of persons or organizations reporting light failures including any title, address, and telephone number.
2. The type of structure.
3. Location of structure (including latitude and longitude, if known, prominent structures, landmarks, etc.).
4. Height of structure above ground level (AGL)/above mean sea level (AMSL), if known.
5. A return to service date.
6. FCC Antenna Registration Number (for structures that are regulated by the FCC).

Note-

1. When the primary lamp in a double obstruction light fails, and the secondary lamp comes on, no report is required. However, when one of the lamps in an incandescent L-864 flashing red beacon fails, it should be reported.

2. After 15 days, the NOTAM is automatically deleted from the system. The sponsor is responsible for calling the nearest FSS to extend the outage date or to report a return to service date.

24. NOTIFICATION OF RESTORATION

As soon as normal operation is restored, notify the same FSS that received the notification of failure. The FCC advises that noncompliance with notification procedures could subject its sponsor to penalties or monetary forfeitures.

25. FCC REQUIREMENT

FCC licensees are required to file an environmental assessment with the Commission when seeking authorization for the use of the high intensity flashing white lighting system on structures located in residential neighborhoods, as defined by the applicable zoning law.

CHAPTER 3. MARKING GUIDELINES

30. PURPOSE

This chapter provides recommended guidelines to make certain structures conspicuous to pilots during daylight hours. One way of achieving this conspicuity is by painting and/or marking these structures. Recommendations on marking structures can vary depending on terrain features, weather patterns, geographic location, and in the case of wind turbines, number of structures and overall layout of design.

31. PAINT COLORS

Alternate sections of aviation orange and white paint should be used as they provide maximum visibility of an obstruction by contrast in colors.

32. PAINT STANDARDS

The following standards should be followed. To be effective, the paint used should meet specific color requirements when freshly applied to a structure. Since all outdoor paints deteriorate with time and it is not practical to give a maintenance schedule for all climates, surfaces should be repainted when the color changes noticeably or its effectiveness is reduced by scaling, oxidation, chipping, or layers of contamination.

a. *Materials and Application.* Quality paint and materials should be selected to provide extra years of service. The paint should be compatible with the surfaces to be painted, including any previous coatings, and suitable for the environmental conditions. Surface preparation and paint application should be in accordance with manufacturer's recommendations.

Note-

In-Service Aviation Orange Color Tolerance Charts are available from private suppliers for determining when repainting is required. The color should be sampled on the upper half of the structure, since weathering is greater there.

b. *Surfaces Not Requiring Paint.* Ladders, decks, and walkways of steel towers and similar structures need not be painted if a smooth surface presents a potential hazard to maintenance personnel. Paint may also be omitted from precision or critical surfaces if it would have an adverse effect on the transmission or radiation characteristics of a signal. However, the overall marking effect of the structure should not be reduced.

c. *Skeletal Structures.* Complete all marking/painting prior to or immediately upon

completion of construction. This applies to catenary support structures, radio and television towers, and similar skeletal structures. To be effective, paint should be applied to all inner and outer surfaces of the framework.

33. PAINT PATTERNS

Paint patterns of various types are used to mark structures. The pattern to be used is determined by the size and shape of the structure. The following patterns are recommended.

a. *Solid Pattern.* Obstacles should be colored aviation orange if the structure has both horizontal and vertical dimensions not exceeding 10.5 feet (3.2m).

b. *Checkerboard Pattern.* Alternating rectangles of aviation orange and white are normally displayed on the following structures:

1. Water, gas, and grain storage tanks.
2. Buildings, as required.

3. Large structures exceeding 10.5 feet (3.2m) across having a horizontal dimension that is equal to or greater than the vertical dimension.

c. *Size of Patterns.* Sides of the checkerboard pattern should measure not less than 5 feet (1.5m) or more than 20 feet (6m) and should be as nearly square as possible. However, if it is impractical because of the size or shape of a structure, the patterns may have sides less than 5 feet (1.5m). When possible, corner surfaces should be colored orange.

d. *Alternate Bands.* Alternate bands of aviation orange and white are normally displayed on the following structures:

1. Communication towers and catenary support structures.

2. Poles.

3. Smokestacks.

4. Skeletal framework of storage tanks and similar structures.

5. Structures which appear narrow from a side view, that are 10.5 feet (3.2m) or more across and the horizontal dimension is less than the vertical dimension.

6. Coaxial cable, conduits, and other cables attached to the face of a tower.

e. Color Band Characteristics. Bands for structures of any height should be:

1. Equal in width, provided each band is not less than 1½ feet (0.5m) or more than 100 feet (31m) wide.
2. Perpendicular to the vertical axis with the bands at the top and bottom ends colored orange.
3. An odd number of bands on the structure.
4. Approximately one-seventh the height if the structure is 700 feet (214m) AGL or less. For each additional 200 feet (61m) or fraction thereof, add one (1) additional orange and one (1) additional white band.
5. Equal and in proportion to the structure's height AGL.

Structure Height to Bandwidth Ratio

Example: If a Structure is:		
Greater Than	But Not More Than	Band Width
10.5 feet (3.2m)	700 feet (214m)	1/7 of height
701 feet (214m)	900 feet (275m)	1/9 of height
901 feet (275m)	1,100 feet (336m)	1/11 of height
1,100 feet (336m)	1,300 feet (397m)	1/13 of height

TBL 1

f. Structures With a Cover or Roof. If the structure has a cover or roof, the highest orange band should be continued to cover the entire top of the structure.

g. Skeletal Structures Atop Buildings. If a flagpole, skeletal structure, or similar object is erected on top of a building, the combined height of the object and building will determine whether marking is recommended; however, only the height of the object under study determines the width of the color bands.

h. Partial Marking. If marking is recommended for only a portion of a structure because of shielding by other objects or terrain, the width of the bands should be determined by the overall height of the structure. A minimum of three bands should be displayed on the upper portion of the structure.

i. Teardrop Pattern. Spherical water storage tanks with a single circular standpipe support may be marked in a teardrop-striped pattern. The tank should show alternate stripes of aviation orange and white. The stripes should extend from the top center of the tank to its supporting standpipe. The width of the stripes should be equal, and the width of each stripe at the greatest girth of the tank should not be less than 5 feet (1.5m) nor more than 15 feet (4.6m).

j. Community Names. If it is desirable to paint the name of the community on the side of a tank, the stripe pattern may be broken to serve this purpose. This open area should have a maximum height of 3 feet (0.9m).

k. Exceptions. Structural designs not conducive to standard markings may be marked as follows:

1. If it is not practical to color the roof of a structure in a checkerboard pattern, it may be colored solid orange.
2. If a spherical structure is not suitable for an exact checkerboard pattern, the shape of the rectangles may be modified to fit the shape of the surface.
3. Storage tanks not suitable for a checkerboard pattern may be colored by alternating bands of aviation orange and white or a limited checkerboard pattern applied to the upper one-third of the structure.
4. The skeletal framework of certain water, gas, and grain storage tanks may be excluded from the checkerboard pattern.

34. MARKERS

Markers are used to highlight structures when it is impractical to make them conspicuous by painting. Markers may also be used in addition to aviation orange and white paint when additional conspicuity is necessary for aviation safety. They should be displayed in conspicuous positions on or adjacent to the structures so as to retain the general definition of the structure. They should be recognizable in clear air from a distance of at least 4,000 feet (1219m) and in all directions from which aircraft are likely to approach. Markers should be distinctively shaped, i.e., spherical or cylindrical, so they are not mistaken for items that are used to convey other information. They should be replaced when faded or otherwise deteriorated.

a. Spherical Markers. Spherical markers are used to identify overhead wires. Markers may be of another shape, i.e., cylindrical, provided the projected area of such markers will not be less than that presented by a spherical marker.

1. Size and Color.

The diameter of the markers used on extensive catenary wires across canyons, lakes, rivers, etc., should be not less than 36 inches (91cm). Smaller 20-inch (51cm) spheres are permitted on less extensive power lines or on power lines below 50 feet (15m) above the ground and within 1,500 feet (458m) of an airport runway end. Each marker should be a solid color such as aviation orange, white, or yellow.

2. Installations.

(a) Spacing. Markers should be spaced equally along the wire at intervals of approximately 200 feet (61m) or a fraction thereof. Intervals between markers should be less in critical areas near runway ends (i.e., 30 to 50 feet (10m to 15m)). They should be displayed on the highest wire or by another means at the same height as the highest wire. Where there is more than one wire at the highest point, the markers may be installed alternately along each wire if the distance between adjacent markers meets the spacing standard. This method allows the weight and wind loading factors to be distributed.

(b) Pattern. An alternating color scheme provides the most conspicuity against all backgrounds. Mark overhead wires by alternating solid colored markers of aviation orange, white, and yellow. Normally, an orange sphere is placed at each end of a line and the spacing is adjusted (not to exceed 200 feet (61m)) to accommodate the rest of the markers. When less than four markers are used, they should all be aviation orange.

b. Flag Markers. Flags are used to mark certain structures or objects when it is technically impractical to use spherical markers or painting. Some examples are temporary construction equipment, cranes, derricks, oil and other drilling rigs. Catenaries should use spherical markers.

1. Minimum Size. Each side of the flag marker should be at least 2 feet (0.6m) in length.

2. Color Patterns. Flags should be colored as follows:

(a) Solid. Aviation orange.

(b) Orange and White. Arrange two triangular sections, one aviation orange and the other white to form a rectangle.

(c) Checkerboard. Flags 3 feet (0.9m) or larger should be a checkerboard pattern of aviation orange and white squares, each 1 foot (0.3m) plus or minus 10 percent.

3. Shape. Flags should be rectangular in shape and have stiffeners to keep them from drooping in calm wind.

4. Display. Flag markers should be displayed around, on top, or along the highest edge of the obstruction. When flags are used to mark extensive or closely grouped obstructions, they should be displayed approximately 50 feet (15m) apart. The flag stakes should be of such strength and height that they will support the flags above all surrounding ground, structures, and/or objects of natural growth.

35. UNUSUAL COMPLEXITIES

The FAA may also recommend appropriate marking in an area where obstructions are so grouped as to present a common obstruction to air navigation.

36. OMISSION OR ALTERNATIVES TO MARKING

There are two alternatives to marking. Either alternative requires FAA review and concurrence.

a. High Intensity Flashing White Lighting Systems. The high intensity lighting systems are more effective than aviation orange and white paint and therefore can be recommended instead of marking. This is particularly true under certain ambient light conditions involving the position of the sun relative to the direction of flight. When high intensity lighting systems are operated during daytime and twilight, other methods of marking may be omitted. When operated 24 hours a day, other methods of marking and lighting may be omitted.

b. Medium Intensity Flashing White Lighting Systems. When medium intensity lighting systems are operated during daytime and twilight on structures 500 feet (153m) AGL or less, other methods of marking may be omitted. When operated 24 hours a day on structures 500 feet (153m) AGL or less, other methods of marking and lighting may be omitted.

Note-

SPONSORS MUST ENSURE THAT ALTERNATIVES TO MARKING ARE COORDINATED WITH THE FCC FOR STRUCTURES UNDER ITS JURISDICTION PRIOR TO MAKING THE CHANGE.

CHAPTER 4. LIGHTING GUIDELINE

40. PURPOSE

This chapter describes the various obstruction lighting systems used to identify structures that an aeronautical study has determined will require added conspicuity. The lighting standards in this circular are the minimum necessary for aviation safety. Recommendations on lighting structures can vary depending on terrain features, weather patterns, geographic location, and in the case of wind turbines, number of structures and overall layout of design.

41. STANDARDS

The standards outlined in this AC are based on the use of light units that meet specified intensities, beam patterns, color, and flash rates as specified in AC 150/5345-43.

These standards may be obtained from:

Department of Transportation
OTS
Subsequent Distribution Office, M-30
Ardmore East Business Center
3341 Q 75th Avenue
Landover, MD 20785

42. LIGHTING SYSTEMS

Obstruction lighting may be displayed on structures as follows:

a. Aviation Red Obstruction Lights. Use flashing beacons and/or steady burning lights during nighttime.

b. Medium Intensity Flashing White Obstruction Lights. Medium intensity flashing white obstruction lights may be used during daytime and twilight with automatically selected reduced intensity for nighttime operation. When this system is used on structures 500 feet (153m) AGL or less in height, other methods of marking and lighting the structure may be omitted. Aviation orange and white paint is always required for daytime marking on structures exceeding 500 feet (153m) AGL. This system is not normally recommended on structures 200 feet (61m) AGL or less.

c. High Intensity Flashing White Obstruction Lights. Use high intensity flashing white obstruction lights during daytime with automatically selected reduced intensities for twilight and nighttime operations. When this system is used, other methods of marking and lighting the structure may be omitted.

This system should not be recommended on structures 500 feet (153m) AGL or less, unless an FAA aeronautical study shows otherwise.

Note-

All flashing lights on a structure should flash simultaneously except for catenary support structures, which have a distinct sequence flashing between levels.

d. Dual Lighting. This system consists of red lights for nighttime and high or medium intensity flashing white lights for daytime and twilight. When a dual lighting system incorporates medium flashing intensity lights on structures 500 feet (153m) or less, or high intensity flashing white lights on structures of any height, other methods of marking the structure may be omitted.

e. Obstruction Lights During Construction. As the height of the structure exceeds each level at which permanent obstruction lights would be recommended, two or more lights of the type specified in the determination should be installed at that level. Temporary high or medium intensity flashing white lights, as recommended in the determination, should be operated 24 hours a day until all permanent lights are in operation. In either case, two or more lights should be installed on the uppermost part of the structure any time it exceeds the height of the temporary construction equipment. They may be turned off for periods when they would interfere with construction personnel. If practical, permanent obstruction lights should be installed and operated at each level as construction progresses. The lights should be positioned to ensure that a pilot has an unobstructed view of at least one light at each level.

f. Obstruction Lights in Urban Areas. When a structure is located in an urban area where there are numerous other white lights (e.g., streetlights, etc.) red obstruction lights with painting or a medium intensity dual system is recommended. Medium intensity lighting is not normally recommended on structures less than 200 feet (61m).

g. Temporary Construction Equipment Lighting. Since there is such a variance in construction cranes, derricks, oil and other drilling rigs, each case should be considered individually. Lights should be installed according to the standards given in Chapters 5, 6, 7, or 8, as they would apply to permanent structures.

43. CATENARY LIGHTING

Lighted markers are available for increased night conspicuity of high-voltage (69KV or greater) transmission line catenary wires. These markers should be used on transmission line catenary wires near airports, heliports, across rivers, canyons, lakes, etc. The lighted markers should be manufacturer certified as recognizable from a minimum distance of 4,000 feet (1219m) under nighttime conditions, minimum visual flight rules (VFR) conditions or having a minimum intensity of at least 32.5 candela. The lighting unit should emit a steady burning red light. They should be used on the highest energized line. If the lighted markers are installed on a line other than the highest catenary, then markers specified in paragraph 34 should be used in addition to the lighted markers. (The maximum distance between the line energizing the lighted markers and the highest catenary above the lighted marker should be no more than 20 feet (6m).) Markers should be distinctively shaped, i.e., spherical, cylindrical, so they are not mistaken for items that are used to convey other information. They should be visible in all directions from which aircraft are likely to approach. The area in the immediate vicinity of the supporting structure's base should be clear of all items and/or objects of natural growth that could interfere with the line-of-sight between a pilot and the structure's lights. Where a catenary wire crossing requires three or more supporting structures, the inner structures should be equipped with enough light units per level to provide a full coverage.

44. INSPECTION, REPAIR AND MAINTENANCE

To ensure the proper candela output for fixtures with incandescent lamps, the voltage provided to the lamp filament should not vary more than plus or minus 3 percent of the rated voltage of the lamp. The input voltage should be measured at the lamp socket with the lamp operating during the hours of normal operation. (For strobes, the input voltage of the power supplies should be within 10 percent of rated voltage.) Lamps should be replaced after being operated for not more than 75 percent of their rated life or immediately upon failure. Flashtubes in a light unit should be replaced immediately upon failure, when the peak effective intensity falls below specification limits or when the fixture begins skipping flashes, or at the manufacturer's recommended intervals. Due to the effects of harsh environments, beacon lenses should be visually inspected for ultraviolet damage, cracks, crazing, dirt

build up, etc., to insure that the certified light output has not deteriorated. (See paragraph 23, for reporting requirements in case of failure.)

45. NONSTANDARD LIGHTS

Moored balloons, chimneys, church steeples, and similar obstructions may be floodlighted by fixed search light projectors installed at three or more equidistant points around the base of each obstruction. The searchlight projectors should provide an average illumination of at least 15 foot-candles over the top one-third of the obstruction.

46. PLACEMENT FACTORS

The height of the structure AGL determines the number of light levels. The light levels may be adjusted slightly, but not to exceed 10 feet (3m), when necessary to accommodate guy wires and personnel who replace or repair light fixtures. Except for catenary support structures, the following factors should be considered when determining the placement of obstruction lights on a structure.

a. Red Obstruction Lighting Systems. The overall height of the structure including all appurtenances such as rods, antennas, obstruction lights, etc., determines the number of light levels.

b. Medium Intensity Flashing White Obstruction Lighting Systems. The overall height of the structure including all appurtenances such as rods, antennas, obstruction lights, etc., determines the number of light levels.

c. High Intensity Flashing White Obstruction Lighting Systems. The overall height of the main structure including all appurtenances such as rods, antennas, obstruction lights, etc., determines the number of light levels.

d. Dual Obstruction Lighting Systems. The overall height of the structure including all appurtenances such as rods, antennas, obstruction lights, etc., is used to determine the number of light levels for a medium intensity white obstruction light/red obstruction dual lighting system. The overall height of the structure including all appurtenances is used to determine the number of light levels for a high intensity white obstruction light/red obstruction dual lighting system.

e. Adjacent Structures. The elevation of the tops of adjacent buildings in congested areas may be used as the equivalent of ground level to determine the proper number of light levels required.

f. *Shielded Lights*. If an adjacent object shields any light, horizontal placement of the lights should be adjusted or additional lights should be mounted on that object to retain or contribute to the definition of the obstruction.

47. MONITORING OBSTRUCTION LIGHTS

Obstruction lighting systems should be closely monitored by visual or automatic means. It is extremely important to visually inspect obstruction lighting in all operating intensities at least once every 24 hours on systems without automatic monitoring. In the event a structure is not readily accessible for visual observation, a properly maintained automatic monitor should be used. This monitor should be designed to register the malfunction of any light on the obstruction regardless of its position or color. When using remote monitoring devices, the communication status and operational status of the system should be confirmed at least once every 24 hours. The monitor (aural or visual) should be located in an area generally occupied by responsible personnel. In some cases, this may require a remote monitor in an attended location. For each structure, a log should be maintained in which daily operations status of the lighting system is recorded. Beacon

lenses should be replaced if serious cracks, crazing, dirt build up, etc., has occurred.

48. ICE SHIELDS

Where icing is likely to occur, metal grates or similar protective ice shields should be installed directly over each light unit to prevent falling ice or accumulations from damaging the light units.

49. DISTRACTION

a. Where obstruction lights may distract operators of vessels in the proximity of a navigable waterway, the sponsor must coordinate with the Commandant, U.S. Coast Guard, to avoid interference with marine navigation.

b. The address for marine information and coordination is:

Chief, Aids to Navigation
 Division (OPN)
 U.S. Coast Guard Headquarters
 2100 2nd Street, SW., Rm. 3610
 Washington, DC 20593-0001
Telephone: (202) 267-0980

CHAPTER 5. RED OBSTRUCTION LIGHT SYSTEM

50. PURPOSE

Red Obstruction lights are used to increase conspicuity during nighttime. Daytime and twilight marking is required. Recommendations on lighting structures can vary depending on terrain features, weather patterns, geographic location, and in the case of wind turbines, number of structures and overall layout of design.

51. STANDARDS

The red obstruction lighting system is composed of flashing omnidirectional beacons (L-864) and/or steady burning (L-810) lights. When one or more levels is comprised of flashing beacon lighting, the lights should flash simultaneously.

a. Single Obstruction Light. A single (L-810) light may be used when more than one obstruction light is required either vertically or horizontally or where maintenance can be accomplished within a reasonable time.

1. Top Level. A single light may be used to identify low structures such as airport ILS buildings and long horizontal structures such as perimeter fences and building roof outlines.

2. Intermediate Level. Single lights may be used on skeletal and solid structures when more than one level of lights is installed and there are two or more single lights per level.

b. Double Obstruction Light. A double (L-810) light should be installed when used as a top light, at each end of a row of single obstruction lights, and in areas or locations where the failure of a single unit could cause an obstruction to be totally unlighted.

1. Top Level. Structures 150 feet (46m) AGL or less should have one or more double lights installed at the highest point and operating simultaneously.

2. Intermediate Level. Double lights should be installed at intermediate levels when a malfunction of a single light could create an unsafe condition and in remote areas where maintenance cannot be performed within a reasonable time. Both units may operate simultaneously, or a transfer relay may be used to switch to a spare unit should the active system fail.

3. Lowest Level. The lowest level of light units may be installed at a higher elevation than normal on a structure if the surrounding terrain, trees, or adjacent building(s) would obscure the lights. In certain instances, as determined by an FAA aeronautical study, the lowest level of lights may be eliminated.

52. CONTROL DEVICE

Red obstruction lights should be operated by a satisfactory control device (e.g., photo cell, timer, etc.) adjusted so the lights will be turned on when the northern sky illuminance reaching a vertical surface falls below a level of 60 foot-candles (645.8 lux) but before reaching a level of 35 foot-candles (367.7 lux). The control device should turn the lights off when the northern sky illuminance rises to a level of not more than 60 foot-candles (645.8 lux). The lights may also remain on continuously. The sensing device should, if practical, face the northern sky in the Northern Hemisphere. (See AC 150/5345-43.)

53. POLES, TOWERS, AND SIMILAR SKELETAL STRUCTURES

The following standards apply to radio and television towers, supporting structures for overhead transmission lines, and similar structures.

a. Top Mounted Obstruction Light.

1. Structures 150 Feet (46m) AGL or Less. Two or more steady burning (L-810) lights should be installed in a manner to ensure an unobstructed view of one or more lights by a pilot.

2. Structures Exceeding 150 Feet (46m) AGL. At least one red flashing (L-864) beacon should be installed in a manner to ensure an unobstructed view of one or more lights by a pilot.

3. Appurtenances 40 Feet (12m) or Less. If a rod, antenna, or other appurtenance 40 feet (12m) or less in height is incapable of supporting a red flashing beacon, then it may be placed at the base of the appurtenance. If the mounting location does not allow unobstructed viewing of the beacon by a pilot, then additional beacons should be added.

4. Appurtenances Exceeding 40 Feet (12m). If a rod, antenna, or other appurtenance exceeding 40 feet (12m) in height is incapable of supporting a red flashing beacon, a supporting mast with one or more beacons should be installed adjacent to the appurtenance. Adjacent installations should not exceed the height of the appurtenance and be within 40 feet (12m) of the tip to allow the pilot an unobstructed view of at least one beacon.

b. Mounting Intermediate Levels. The number of light levels is determined by the height of the structure, including all appurtenances, and is detailed in Appendix 1. The number of lights on each level is

determined by the shape and height of the structure. These lights should be mounted so as to ensure an unobstructed view of at least one light by a pilot.

1. *Steady Burning Lights (L-810).*

(a) *Structures 350 Feet (107m) AGL or Less.*

Two or more steady burning (L-810) lights should be installed on diagonally or diametrically opposite positions.

(b) *Structures Exceeding 350 Feet (107m)*

AGL. Install steady burning (L-810) lights on each outside corner of each level.

2. *Flashing Beacons (L-864).*

(a) *Structures 350 Feet (107m) AGL or Less.*

These structures do not require flashing (L-864) beacons at intermediate levels.

(b) *Structure Exceeding 350 Feet (107m)*

AGL. At intermediate levels, two beacons (L-864) should be mounted outside at diagonally opposite positions of intermediate levels.

54. CHIMNEYS, FLARE STACKS, AND SIMILAR SOLID STRUCTURES

a. *Number of Light Units.*

1. The number of units recommended depends on the diameter of the structure at the top. The number of lights recommended below are the minimum.

2. When the structure diameter is:

(a) *20 Feet (6m) or Less.* Three light units per level.

(b) *Exceeding 20 Feet (6m) But Not More Than 100 Feet (31m).* Four light units per level.

(c) *Exceeding 100 Feet (31m) But Not More Than 200 Feet (61m).* Six light units per level.

(d) *Exceeding 200 Feet (61m).* Eight light units per level.

b. *Top Mounted Obstruction Lights.*

1. *Structures 150 Feet (46m) AGL or Less.* L-810 lights should be installed horizontally at regular intervals at or near the top.

2. *Structures Exceeding 150 Feet (46m) AGL.* At least three L-864 beacons should be installed.

3. *Chimneys, Cooling Towers, and Flare Stacks.* Lights may be displayed as low as 20 feet (6m) below the top to avoid the obscuring effect of deposits and heat generally emitted by this type of structure. It is important that these lights be readily accessible for

cleaning and lamp replacement. It is understood that with flare stacks, as well as any other structures associated with the petrol-chemical industry, normal lighting requirements may not be necessary. This could be due to the location of the flare stack/structure within a large well-lighted petrol-chemical plant or the fact that the flare, or working lights surrounding the flare stack/structure, is as conspicuous as obstruction lights.

c. *Mounting Intermediate Levels.* The number of light levels is determined by the height of the structure including all appurtenances. For cooling towers 600 feet (183m) or less, intermediate light levels are not necessary. Structures exceeding 600 feet (183m) AGL should have a second level of light units installed approximately at the midpoint of the structure and in a vertical line with the top level of lights.

1. *Steady Burning (L-810) Lights.* The recommended number of light levels may be obtained from Appendix 1. At least three lights should be installed on each level.

2. *Flashing (L-864) Beacons.* The recommended number of beacon levels may be obtained from Appendix 1. At least three lights should be installed on each level.

(a) *Structures 350 Feet (107m) AGL or Less.* These structures do not need intermediate levels of flashing beacons.

(b) *Structures Exceeding 350 Feet (107m) AGL.* At least three flashing (L-864) beacons should be installed on each level in a manner to allow an unobstructed view of at least one beacon.

55. GROUP OF OBSTRUCTIONS

When individual objects, except wind turbines, within a group of obstructions are not the same height and are spaced a maximum of 150 feet (46m) apart, the prominent objects within the group should be lighted in accordance with the standards for individual obstructions of a corresponding height. If the outer structure is shorter than the prominent, the outer structure should be lighted in accordance with the standards for individual obstructions of a corresponding height. Light units should be placed to ensure that the light is visible to a pilot approaching from **any** direction. In addition, at least one flashing beacon should be installed at the top of a prominent center obstruction or on a special tower located near the center of the group.

56. ALTERNATE METHOD OF DISPLAYING OBSTRUCTION LIGHTS

When recommended in an FAA aeronautical study, lights may be placed on poles equal to the height of the obstruction and installed on or adjacent to the structure instead of installing lights on the obstruction.

57. PROMINENT BUILDINGS, BRIDGES, AND SIMILAR EXTENSIVE OBSTRUCTIONS

When objects within a group of obstructions are approximately the same overall height above the surface and are located a maximum of 150 feet (46m) apart, the group of obstructions may be considered an extensive obstruction. Install light units on the same horizontal plane at the highest portion or edge of prominent obstructions. Light units should be placed to ensure that the light is visible to a pilot approaching from **any** direction. If the structure is a bridge and is over navigable water, the sponsor must obtain prior approval of the lighting installation from the Commander of the District Office of the United States Coast Guard to avoid interference with marine navigation. Steady burning lights should be displayed to indicate the extent of the obstruction as follows:

a. Structures 150 Feet (46m) or Less in Any Horizontal Direction. If the structure/bridge/extensive obstruction is 150 feet (46m) or less horizontally, at least one steady burning light (L-810) should be displayed on the highest point at each end of the major axis of the obstruction. If this is impractical because of the overall shape, display a double obstruction light in the center of the highest point.

b. Structures Exceeding 150 Feet (46m) in at Least One Horizontal Direction. If the structure/bridge/extensive obstruction exceeds 150 feet (46m) horizontally, display at least one steady burning light for each 150 feet (46m), or fraction thereof, of the

overall length of the major axis. At least one of these lights should be displayed on the highest point at each end of the obstruction. Additional lights should be displayed at approximately equal intervals not to exceed 150 feet (46m) on the highest points along the edge between the end lights. If an obstruction is located near a landing area and two or more edges are the same height, the edge nearest the landing area should be lighted.

c. Structures Exceeding 150 Feet (46m) AGL. Steady burning red obstruction lights should be installed on the highest point at each end. At intermediate levels, steady burning red lights should be displayed for each 150 feet (46m) or fraction thereof. The vertical position of these lights should be equidistant between the top lights and the ground level as the shape and type of obstruction will permit. One such light should be displayed at each outside corner on each level with the remaining lights evenly spaced between the corner lights.

d. Exceptions. Flashing red beacons (L-864) may be used instead of steady burning obstruction lights if early or special warning is necessary. These beacons should be displayed on the highest points of an extensive obstruction at intervals not exceeding 3,000 feet (915m). At least three beacons should be displayed on one side of the extensive obstruction to indicate a line of lights.

e. Ice Shields. Where icing is likely to occur, metal grates or similar protective ice shields should be installed directly over each light unit to prevent falling ice or accumulations from damaging the light units. The light should be mounted in a manner to ensure an unobstructed view of at least one light by a pilot approaching from any direction.

CHAPTER 6. MEDIUM INTENSITY FLASHING WHITE OBSTRUCTION LIGHT SYSTEMS

60. PURPOSE

Medium intensity flashing white (L-865) obstruction lights may provide conspicuity both day and night. Recommendations on lighting structures can vary depending on terrain features, weather patterns, geographic location, and in the case of wind turbines, number of structures and overall layout of design.

61. STANDARDS

The medium intensity flashing white light system is normally composed of flashing omnidirectional lights. Medium intensity flashing white obstruction lights may be used during daytime and twilight with automatically selected reduced intensity for nighttime operation. When this system is used on structures 500 feet (153m) AGL or less in height, other methods of marking and lighting the structure may be omitted. Aviation orange and white paint is always required for daytime marking on structures exceeding 500 feet (153m) AGL. This system is not normally recommended on structures 200 feet (61m) AGL or less.

The use of a 24-hour medium intensity flashing white light system in urban/populated areas is not normally recommended due to their tendency to merge with background lighting in these areas at night. This makes it extremely difficult for some types of aviation operations, i.e., med-evac, and police helicopters to see these structures. The use of this type of system in urban and rural areas often results in complaints. In addition, this system is not recommended on structures within 3 nautical miles of an airport.

62. RADIO AND TELEVISION TOWERS AND SIMILAR SKELETAL STRUCTURES

a. Mounting Lights. The number of levels recommended depends on the height of the structure, including antennas and similar appurtenances.

1. Top Levels. One or more lights should be installed at the highest point to provide 360-degree coverage ensuring an unobstructed view.

2. Appurtenances 40 feet (12m) or less. If a rod, antenna, or other appurtenance 40 feet (12m) or less in height is incapable of supporting the medium intensity flashing white light, then it may be placed at the base of the appurtenance. If the mounting location does not allow unobstructed viewing of the medium intensity flashing white light by a pilot, then additional lights should be added.

3. Appurtenances Exceeding 40 feet (12m). If a rod, antenna, or other appurtenance exceeds 40 feet (12m) above the tip of the main structure, a medium intensity flashing white light should be placed within 40 feet (12m) from the top of the appurtenance. If the appurtenance (such as a whip antenna) is incapable of supporting the light, one or more lights should be mounted on a pole adjacent to the appurtenance. Adjacent installations should not exceed the height of the appurtenance and be within 40 feet (12m) of the tip to allow the pilot an unobstructed view of at least one light.

b. Intermediate Levels. At intermediate levels, two beacons (L-865) should be mounted outside at diagonally or diametrically opposite positions of intermediate levels. The lowest light level should not be less than 200 feet (61m) AGL.

c. Lowest Levels. The lowest level of light units may be installed at a higher elevation than normal on a structure if the surrounding terrain, trees, or adjacent building(s) would obscure the lights. In certain instances, as determined by an FAA aeronautical study, the lowest level of lights may be eliminated.

d. Structures 500 Feet (153m) AGL or Less. When white lights are used during nighttime and twilight only, marking is required for daytime. When operated 24 hours a day, other methods of marking and lighting are not required.

e. Structures Exceeding 500 Feet (153m) AGL. The lights should be used during nighttime and twilight and may be used 24 hours a day. Marking is always required for daytime.

f. Ice Shields. Where icing is likely to occur, metal grates or similar protective ice shields should be installed directly over each light unit to prevent falling ice or accumulations from damaging the light units. The light should be mounted in a manner to ensure an unobstructed view of at least one light by a pilot approaching from any direction.

63. CONTROL DEVICE

The light intensity is controlled by a device that changes the intensity when the ambient light changes. The system should automatically change intensity steps when the northern sky illumination in the Northern Hemisphere on a vertical surface is as follows:

a. Twilight-to-Night. This should not occur before the illumination drops below five foot-candles (53.8

lux) but should occur before it drops below two foot-candles (21.5 lux).

b. Night-to-Day. The intensity changes listed in subparagraph 63a above should be reversed when changing from the night to day mode.

64. CHIMNEYS, FLARE STACKS, AND SIMILAR SOLID STRUCTURES

a. Number of Light Units. The number of units recommended depends on the diameter of the structure at the top. Normally, the top level is on the highest point of a structure. However, the top level of chimney lights may be installed as low as 20 feet (6m) below the top to minimize deposit build-up due to emissions. The number of lights recommended are the minimum. When the structure diameter is:

1. *20 Feet (6m) or Less.* Three light units per level.
2. *Exceeding 20 Feet (6m) But Not More Than 100 Feet (31m).* Four light units per level.
3. *Exceeding 100 Feet (31m) But Not More Than 200 Feet (61m).* Six light units per level.
4. *Exceeding 200 Feet (61m).* Eight light units per level.

65. GROUP OF OBSTRUCTIONS

When individual objects within a group of obstructions are not the same height and are spaced a maximum of 150 feet (46m) apart, the prominent objects within the group should be lighted in accordance with the standards for individual obstructions of a corresponding height. If the outer structure is shorter than the prominent, the outer structure should be lighted in accordance with the standards for individual obstructions of a corresponding height. Light units should be placed to ensure that the light is visible to a pilot approaching from **any** direction. In addition, at least one medium intensity flashing white light should be installed at the top of a prominent center obstruction or on a special tower located near the center of the group.

66. SPECIAL CASES

Where lighting systems are installed on structures located near highways, waterways, airport approach areas, etc., caution should be exercised to ensure that the lights do not distract or otherwise cause a hazard to motorists, vessel operators, or pilots on an approach to an airport. In these cases, shielding may be necessary.

This shielding should not derogate the intended purpose of the lighting system.

67. PROMINENT BUILDINGS AND SIMILAR EXTENSIVE OBSTRUCTIONS

When objects within a group of obstructions are approximately the same overall height above the surface and are located a maximum of 150 feet (46m) apart, the group of obstructions may be considered an extensive obstruction. Install light units on the same horizontal plane at the highest portion or edge of prominent obstructions. Light units should be placed to ensure that the light is visible to a pilot approaching from **any** direction. Lights should be displayed to indicate the extent of the obstruction as follows:

a. Structures 150 Feet (46m) or Less in Any Horizontal Direction. If the structure/extensive obstruction is 150 feet (46m) or less horizontally, at least one light should be displayed on the highest point at each end of the major axis of the obstruction. If this is impractical because of the overall shape, display a double obstruction light in the center of the highest point.

b. Structures Exceeding 150 Feet (46m) in at Least One Horizontal Direction. If the structure/extensive obstruction exceeds 150 feet (46m) horizontally, display at least one light for each 150 feet (46m) or fraction thereof, of the overall length of the major axis. At least one of these lights should be displayed on the highest point at each end of the obstruction. Additional lights should be displayed at approximately equal intervals not to exceed 150 feet (46m) on the highest points along the edge between the end lights. If an obstruction is located near a landing area and two or more edges are the same height, the edge nearest the landing area should be lighted.

c. Structures Exceeding 150 Feet (46m) AGL. Lights should be installed on the highest point at each end. At intermediate levels, lights should be displayed for each 150 feet (46m), or fraction thereof. The vertical position of these lights should be equidistant between the top lights and the ground level as the shape and type of obstruction will permit. One such light should be displayed at each outside corner on each level with the remaining lights evenly spaced between the corner lights.

CHAPTER 7. HIGH INTENSITY FLASHING WHITE OBSTRUCTION LIGHT SYSTEMS

70. PURPOSE

Lighting with high intensity (L-856) flashing white obstruction lights provides the highest degree of conspicuity both day and night. Recommendations on lighting structures can vary depending on terrain features, weather patterns, geographic location, and in the case of wind turbines, number of structures and overall layout of design.

71. STANDARDS

Use high intensity flashing white obstruction lights during daytime with automatically selected reduced intensities for twilight and nighttime operations. When high intensity white lights are operated 24 hours a day, other methods of marking and lighting may be omitted. This system should not be recommended on structures 500 feet (153m) AGL or less unless an FAA aeronautical study shows otherwise.

72. CONTROL DEVICE

Light intensity is controlled by a device that changes the intensity when the ambient light changes. The use of a 24-hour high intensity flashing white light system in urban/populated areas is not normally recommended due to their tendency to merge with background lighting in these areas at night. This makes it extremely difficult for some types of aviation operations, i.e., med-evac, and police helicopters to see these structures. The use of this type of system in urban and rural areas often results in complaints.

The system should automatically change intensity steps when the northern sky illumination in the Northern Hemisphere on a vertical surface is as follows:

- a. Day-to-Twilight.** This should not occur before the illumination drops to 60 foot-candles (645.8 lux), but should occur before it drops below 35 foot-candles (376.7 lux). The illuminance-sensing device should, if practical, face the northern sky in the Northern Hemisphere.
- b. Twilight-to-Night.** This should not occur before the illumination drops below five foot-candles (53.8 lux), but should occur before it drops below two foot-candles (21.5 lux).
- c. Night-to-Day.** The intensity changes listed in subparagraph 72 a and b above should be reversed when changing from the night to day mode.

73. UNITS PER LEVEL

One or more light units is needed to obtain the desired horizontal coverage. The number of light units recommended per level (except for the supporting structures of catenary wires and buildings) depends upon the average outside diameter of the specific structure, and the horizontal beam width of the light fixture. The light units should be installed in a manner to ensure an unobstructed view of the system by a pilot approaching from any direction. The number of lights recommended are the minimum. When the structure diameter is:

- a. 20 Feet (6m) or Less.** Three light units per level.
- b. Exceeding 20 Feet (6m) But Not More Than 100 Feet (31m).** Four light units per level.
- c. Exceeding 100 Feet (31m).** Six light units per level.

74. INSTALLATION GUIDANCE

Manufacturing specifications provide for the effective peak intensity of the light beam to be adjustable from zero to 8 degrees above the horizon. Normal installation should place the top light at zero degrees to the horizontal and all other light units installed in accordance with Table 2:

Light Unit Elevation Above the Horizontal	
Height of Light Unit Above Terrain	Degrees of Elevation Above the Horizontal
Exceeding 500 feet AGL	0
401 feet to 500 feet AGL	1
301 feet to 400 feet AGL	2
300 feet AGL or less	3

TBL 2

- a. Vertical Aiming.** Where terrain, nearby residential areas, or other situations dictate, the light beam may be further elevated above the horizontal. The main beam of light at the lowest level should not strike the ground closer than 3 statute miles (5km) from the structure. If additional adjustments are necessary, the lights may be individually adjusted upward, in 1-degree increments, starting at the bottom. Excessive elevation may reduce its conspicuity by raising the beam above a collision course flight path.
- b. Special Cases.** Where lighting systems are installed on structures located near highways, waterways, airport approach areas, etc., caution should be exercised to ensure that the lights do not distract or otherwise cause a hazard to motorists, vessel operators, or pilots on an approach to an airport. In these cases,

shielding or an adjustment to the vertical or horizontal light aiming may be necessary. This adjustment should not derogate the intended purpose of the lighting system. Such adjustments may require review action as described in Chapter 1, paragraph 5.

c. Relocation or Omission of Light Units. Light units should not be installed in such a manner that the light pattern/output is disrupted by the structure.

1. Lowest Level. The lowest level of light units may be installed at a higher elevation than normal on a structure if the surrounding terrain, trees, or adjacent building(s) would obscure the lights. In certain instances, as determined by an FAA aeronautical study, the lowest level of lights may be eliminated.

2. Two Adjacent Structures. Where two structures are situated within 500 feet (153m) of each other and the light units are installed at the same levels, the sides of the structures facing each other need not be lighted. However, all lights on both structures must flash simultaneously, except for adjacent catenary support structures. Adjust vertical placement of the lights to either or both structures' intermediate levels to place the lights on the same horizontal plane. Where one structure is higher than the other, complete level(s) of lights should be installed on that part of the higher structure that extends above the top of the lower structure. If the structures are of such heights that the levels of lights cannot be placed in identical horizontal planes, then the light units should be placed such that the center of the horizontal beam patterns do not face toward the adjacent structure. For example, structures situated north and south of each other should have the light units on both structures installed on a northwest/southeast and northeast/southwest orientation.

3. Three or More Adjacent Structures. The treatment of a cluster of structures as an individual or a complex of structures will be determined by the FAA as the result of an aeronautical study, taking into consideration the location, heights, and spacing with other structures.

75. ANTENNA OR SIMILAR APPURTENANCE LIGHT

When a structure lighted by a high intensity flashing light system is topped with an antenna or similar appurtenance exceeding 40 feet (12m) in height, a medium intensity flashing white light (L-865) should be placed within 40 feet (12m) from the tip of the

appurtenance. This light should operate 24 hours a day and flash simultaneously with the rest of the lighting system.

76. CHIMNEYS, FLARE STACKS, AND SIMILAR SOLID STRUCTURES

The number of light levels depends on the height of the structure excluding appurtenances. Three or more lights should be installed on each level in such a manner to ensure an unobstructed view by the pilot. Normally, the top level is on the highest point of a structure. However, the top level of chimney lights may be installed as low as 20 feet (6m) below the top to minimize deposit build-up due to emissions.

77. RADIO AND TELEVISION TOWERS AND SIMILAR SKELETAL STRUCTURES

a. Mounting Lights. The number of levels recommended depends on the height of the structure, including antennas and similar appurtenances. At least three lights should be installed on each level and mounted to ensure that the effective intensity of the full horizontal beam coverage is not impaired by the structural members.

b. Top Level. One level of lights should be installed at the highest point of the structure. If the highest point is a rod or antenna incapable of supporting a lighting system, then the top level of lights should be installed at the highest portion of the main skeletal structure. When guy wires come together at the top, it may be necessary to install this level of lights as low as 10 feet (3m) below the top. If the rod or antenna exceeds 40 feet (12m) above the main structure, a medium intensity flashing white light (L-865) should be mounted on the highest point. If the appurtenance (such as a whip antenna) is incapable of supporting a medium intensity light, one or more lights should be installed on a pole adjacent to the appurtenance. Adjacent installation should not exceed the height of the appurtenance and be within 40 feet (12m) of the top to allow an unobstructed view of at least one light.

c. Ice Shields. Where icing is likely to occur, metal grates or similar protective ice shields should be installed directly over each light unit to prevent falling ice or accumulations from damaging the light units.

78. HYPERBOLIC COOLING TOWERS

Light units should be installed in a manner to ensure an unobstructed view of at least two lights by a pilot approaching from **any** direction.

a. Number of Light Units. The number of units recommended depends on the diameter of the structure

at the top. The number of lights recommended in the following table are the minimum. When the structure diameter is:

1. *20 Feet (6m) or Less.* Three light units per level.

2. *Exceeding 20 Feet (6m) But Not More Than 100 Feet (31m).* Four light units per level.

3. *Exceeding 100 Feet (31m) But Not More Than 200 Feet (61m).* Six light units per level.

4. *Exceeding 200 Feet (61m).* Eight light units per level.

b. Structures Exceeding 600 Feet (183m) AGL. Structures exceeding 600 feet (183m) AGL should have a second level of light units installed approximately at the midpoint of the structure and in a vertical line with the top level of lights.

79. PROMINENT BUILDINGS AND SIMILAR EXTENSIVE OBSTRUCTIONS

When objects within a group of obstructions are approximately the same overall height above the surface and are located not more than 150 feet (46m) apart, the group of obstructions may be considered an extensive obstruction. Install light units on the same horizontal plane at the highest portion or edge of prominent obstructions. Light units should be placed

to ensure that the light is visible to a pilot approaching from **any** direction. These lights may require shielding, such as louvers, to ensure minimum adverse impact on local communities. Extreme caution in the use of high intensity flashing white lights should be exercised.

a. If the Obstruction is 200 feet (61m) or Less in Either Horizontal Dimension, install three or more light units at the highest portion of the structure in a manner to ensure that at least one light is visible to a pilot approaching from **any** direction. Units may be mounted on a single pedestal at or near the center of the obstruction. If light units are placed more than 10 feet (3m) from the center point of the structure, use a minimum of four units.

b. If the Obstruction Exceeds 200 Feet (61m) in One Horizontal Dimension, but is 200 feet (61m) or less in the other, two light units should be placed on each of the shorter sides. These light units may either be installed adjacent to each other at the midpoint of the edge of the obstruction or at (near) each corner with the light unit aimed to provide 180 degrees of coverage at each edge. One or more light units should be installed along the overall length of the major axis. These lights should be installed at approximately equal intervals not to exceed a distance of 100 feet (31m) from the corners or from each other.

c. If the Obstruction Exceeds 200 Feet (61m) in Both Horizontal Dimensions, light units should be equally spaced along the overall perimeter of the obstruction at intervals of 100 feet (31m) or fraction thereof.

CHAPTER 8. DUAL LIGHTING WITH RED/MEDIUM INTENSITY FLASHING WHITE SYSTEMS

80. PURPOSE

This dual lighting system includes red lights (L-864) for nighttime and medium intensity flashing white lights (L-865) for daytime and twilight use. This lighting system may be used in lieu of operating a medium intensity flashing white lighting system at night. There may be some populated areas where the use of medium intensity at night may cause significant environmental concerns. The use of the dual lighting system should reduce/mitigate those concerns. Recommendations on lighting structures can vary depending on terrain features, weather patterns, geographic location, and in the case of wind turbines, number of structures and overall layout of design.

81. INSTALLATION

The light units should be installed as specified in the appropriate portions of Chapters 4, 5, and 6. The number of light levels needed may be obtained from Appendix 1.

82. OPERATION

Lighting systems should be operated as specified in Chapter 3. Both systems should not be operated at the same time; however, there should be no more than a 2-second delay when changing from one system to the other. Outage of one of two lamps in the uppermost red beacon (L-864 incandescent unit) or outage of any uppermost red light shall cause the white obstruction light system to operate in its specified "night" step intensity.

83. CONTROL DEVICE

The light system is controlled by a device that changes the system when the ambient light changes. The system should automatically change steps when the northern sky illumination in the Northern Hemisphere on a vertical surface is as follows:

a. *Twilight-to-Night.* This should not occur before the illumination drops below 5 foot-candles (53.8 lux) but should occur before it drops below 2 foot-candles (21.5 lux).

b. *Night-to-Day.* The intensity changes listed in subparagraph 83 a above should be reversed when changing from the night to day mode.

84. ANTENNA OR SIMILAR APPURTENANCE LIGHT

When a structure utilizing this dual lighting system is topped with an antenna or similar appurtenance exceeding 40 feet (12m) in height, a medium intensity flashing white (L-865) and a red flashing beacon (L-864) should be placed within 40 feet (12m) from the tip of the appurtenance. The white light should operate during daytime and twilight and the red light during nighttime. These lights should flash simultaneously with the rest of the lighting system.

85. OMISSION OF MARKING

When medium intensity white lights are operated on structures 500 feet (153m) AGL or less during daytime and twilight, other methods of marking may be omitted.

CHAPTER 9. DUAL LIGHTING WITH RED/HIGH INTENSITY FLASHING WHITE SYSTEMS**90. PURPOSE**

This dual lighting system includes red lights (L-864) for nighttime and high intensity flashing white lights (L-856) for daytime and twilight use. This lighting system may be used in lieu of operating a flashing white lighting system at night. There may be some populated areas where the use of high intensity lights at night may cause significant environmental concerns and complaints. The use of the dual lighting system should reduce/mitigate those concerns. Recommendations on lighting structures can vary depending on terrain features, weather patterns, geographic location, and in the case of wind turbines, number of structures and overall layout of design.

91. INSTALLATION

The light units should be installed as specified in the appropriate portions of Chapters 4, 5, and 7. The number of light levels needed may be obtained from Appendix 1.

92. OPERATION

Lighting systems should be operated as specified in Chapters 4, 5, and 7. Both systems should not be operated at the same time; however, there should be no more than a 2-second delay when changing from one system to the other. Outage of one of two lamps in the uppermost red beacon (L-864 incandescent unit) or outage of any uppermost red light shall cause the white obstruction light system to operate in its specified "night" step intensity.

93. CONTROL DEVICE

The light intensity is controlled by a device that changes the intensity when the ambient light changes.

The system should automatically change intensity steps when the northern sky illumination in the Northern Hemisphere on a vertical surface is as follows:

a. Day-to-Twilight. This should not occur before the illumination drops to 60 foot-candles (645.8 lux) but should occur before it drops below 35 foot-candles (376.7 lux). The illuminance-sensing device should, if practical, face the northern sky in the Northern Hemisphere.

b. Twilight-to-Night. This should not occur before the illumination drops below 5 foot-candles (53.8 lux) but should occur before it drops below 2 foot-candles (21.5 lux).

c. Night-to-Day. The intensity changes listed in subparagraph 93 a and b above should be reversed when changing from the night to day mode.

94. ANTENNA OR SIMILAR APPURTENANCE LIGHT

When a structure utilizing this dual lighting system is topped with an antenna or similar appurtenance exceeding 40 feet (12m) in height, a medium intensity flashing white light (L-865) and a red flashing beacon (L-864) should be placed within 40 feet (12m) from the tip of the appurtenance. The white light should operate during daytime and twilight and the red light during nighttime.

95. OMISSION OF MARKING

When high intensity white lights are operated during daytime and twilight, other methods of marking may be omitted.

CHAPTER 10. MARKING AND LIGHTING OF CATENARY AND CATENARY SUPPORT STRUCTURES

100. PURPOSE

This chapter provides guidelines for marking and lighting catenary and catenary support structures. The recommended marking and lighting of these structures is intended to provide day and night conspicuity and to assist pilots in identifying and avoiding catenary wires and associated support structures.

101. CATENARY MARKING STANDARDS

Lighted markers are available for increased night conspicuity of high-voltage (69KV or greater) transmission line catenary wires. These markers should be used on transmission line catenary wires near airports, heliports, across rivers, canyons, lakes, etc. The lighted markers should be manufacturer certified as recognizable from a minimum distance of 4,000 feet (1219m) under nighttime conditions, minimum VFR conditions or having a minimum intensity of at least 32.5 candela. The lighting unit should emit a steady burning red light. They should be used on the highest energized line. If the lighted markers are installed on a line other than the highest catenary, then markers specified in paragraph 34 should be used in addition to the lighted markers. (The maximum distance between the line energizing the lighted markers and the highest catenary above the lighted marker should be no more than 20 feet (6m).) Markers should be distinctively shaped, i.e., spherical, cylindrical, so they are not mistaken for items that are used to convey other information. They should be visible in all directions from which aircraft are likely to approach. The area in the immediate vicinity of the supporting structure's base should be clear of all items and/or objects of natural growth that could interfere with the line-of-sight between a pilot and the structure's lights. Where a catenary wire crossing requires three or more supporting structures, the inner structures should be equipped with enough light units per level to provide a full coverage.

a. Size and Color. The diameter of the markers used on extensive catenary wires across canyons, lakes, rivers, etc., should be not less than 36 inches (91cm). Smaller 20-inch (51cm) markers are permitted on less extensive power lines or on power lines below 50 feet (15m) above the ground and within 1,500 feet (458m) of an airport runway end. Each marker should be a solid color such as aviation orange, white, or yellow.

b. Installation.

1. Spacing. Lighted markers should be spaced equally along the wire at intervals of approximately 200 feet (61m) or a fraction thereof. Intervals between

markers should be less in critical areas near runway ends, i.e., 30 to 50 feet (10m to 15m). If the markers are installed on a line other than the highest catenary, then markers specified in paragraph 34 should be used in addition to the lighted markers. The maximum distance between the line energizing the lighted markers and the highest catenary above the markers can be no more than 20 feet (6m). The lighted markers may be installed alternately along each wire if the distance between adjacent markers meets the spacing standard. This method allows the weight and wind loading factors to be distributed.

2. Pattern. An alternating color scheme provides the most conspicuity against all backgrounds. Mark overhead wires by alternating solid colored markers of aviation orange, white, and yellow. Normally, an orange marker is placed at each end of a line and the spacing is adjusted (not to exceed 200 feet (61m)) to accommodate the rest of the markers. When less than four markers are used, they should all be aviation orange.

102. CATENARY LIGHTING STANDARDS

When using medium intensity flashing white (L-866), high intensity flashing white (L-857), dual medium intensity (L-866/L-885) or dual high intensity (L-857/885) lighting systems, operated 24 hours a day, other marking of the support structure is not necessary.

a. Levels. A system of three levels of sequentially flashing light units should be installed on each supporting structure or adjacent terrain. Install one level at the top of the structure, one at the height of the lowest point in the catenary and one level approximately midway between the other two light levels. The middle level should normally be at least 50 feet (15m) from the other two levels. The middle light unit may be deleted when the distance between the top and the bottom light levels is less than 100 feet (30m).

1. Top Levels. One or more lights should be installed at the top of the structure to provide 360-degree coverage ensuring an unobstructed view. If the installation presents a potential danger to maintenance personnel, or when necessary for lightning protection, the top level of lights may be mounted as low as 20 feet (6m) below the highest point of the structure.

2. Horizontal Coverage. The light units at the middle level and bottom level should be installed so as to provide a minimum of 180-degree coverage centered perpendicular to the flyway. Where a catenary crossing is situated near a bend in a river, canyon, etc., or is not perpendicular to the flyway, the

horizontal beam should be directed to provide the most effective light coverage to warn pilots approaching from either direction of the catenary wires.

3. Variation. The vertical and horizontal arrangements of the lights may be subject to the structural limits of the towers and/or adjacent terrain. A tolerance of 20 percent from uniform spacing of the bottom and middle light is allowed. If the base of the supporting structure(s) is higher than the lowest point in the catenary, such as a canyon crossing, one or more lights should be installed on the adjacent terrain at the level of the lowest point in the span. These lights should be installed on the structure or terrain at the height of the lowest point in the catenary.

b. Flash Sequence. The flash sequence should be middle, top, and bottom with all lights on the same level flashing simultaneously. The time delay between flashes of levels is designed to present a unique system display. The time delay between the start of each level of flash duration is outlined in FAA AC 150/5345-43, Specification for Obstruction Lighting Equipment.

c. Synchronization. Although desirable, the corresponding light levels on associated supporting towers of a catenary crossing need not flash simultaneously.

d. Structures 500 feet (153m) AGL or Less. When medium intensity white lights (L-866) are operated 24 hours a day, or when a dual red/medium intensity system (L-866 daytime & twilight/L-885 nighttime) is used, marking can be omitted. When using a medium intensity white light (L-866) or a flashing red light (L-885) during twilight or nighttime only, painting should be used for daytime marking.

e. Structures Exceeding 500 Feet (153m) AGL. When high intensity white lights (L-857) are operated 24 hours a day, or when a dual red/high intensity system (L-857 daytime and twilight/L-885 nighttime) is used, marking can be omitted. This system should not be recommended on structures 500 feet (153m) or less unless an FAA aeronautical study shows otherwise. When a flashing red obstruction light (L-885), a medium intensity (L-866) flashing white lighting system or a high intensity white lighting system (L-857) is used for nighttime and twilight only, painting should be used for daytime marking.

103. CONTROL DEVICE

The light intensity is controlled by a device (photo cell) that changes the intensity when the ambient light changes. The lighting system should automatically change intensity steps when the northern sky illumination in the Northern Hemisphere on a vertical surface is as follows:

a. Day-to-Twilight (L-857 System). This should not occur before the illumination drops to 60 foot-candles (645.8 lux), but should occur before it drops below 35 foot-candles (376.7 lux). The illuminant-sensing device should, if practical, face the northern sky in the Northern Hemisphere.

b. Twilight-to-Night (L-857 System). This should not occur before the illumination drops below 5 foot-candles (53.8 lux), but should occur before it drops below 2 foot-candles (21.5 lux).

c. Night-to-Day. The intensity changes listed in subparagraph 103 a. and b. above should be reversed when changing from the night to day mode.

d. Day-to-Night (L-866 or L-885/L-866). This should not occur before the illumination drops below 5 foot-candles (563.8 lux) but should occur before it drops below 2 foot-candles (21.5 lux).

e. Night-to-Day. The intensity changes listed in subparagraph d. above should be reversed when changing from the night to day mode.

f. Red Obstruction (L-885). The red lights should not turn on until the illumination drops below 60 foot-candles (645.8 lux) but should occur before reaching a level of 35 foot-candles (367.7 lux). Lights should not turn off before the illuminance rises above 35 foot-candles (367.7 lux), but should occur before reaching 60 foot-candles (645.8 lux).

104. AREA SURROUNDING CATENARY SUPPORT STRUCTURES

The area in the immediate vicinity of the supporting structure's base should be clear of all items and/or objects of natural growth that could interfere with the line-of-sight between a pilot and the structure's lights.

105. THREE OR MORE CATENARY SUPPORT STRUCTURES

Where a catenary wire crossing requires three or more supporting structures, the inner structures should be equipped with enough light units per level to provide a full 360-degree coverage.

CHAPTER 11. MARKING AND LIGHTING MOORED BALLOONS AND KITES

110. PURPOSE

The purpose of marking and lighting moored balloons, kites, and their cables or mooring lines is to indicate the presence and general definition of these objects to pilots when converging from any normal angle of approach.

111. STANDARDS

These marking and lighting standards pertain to all moored balloons and kites that require marking and lighting under 14 CFR, part 101.

112. MARKING

Flag markers should be used on mooring lines to warn pilots of their presence during daylight hours.

a. Display. Markers should be displayed at no more than 50-foot (15m) intervals and should be visible for at least 1 statute mile.

b. Shape. Markers should be rectangular in shape and not less than 2 feet (0.6m) on a side. Stiffeners should be used in the borders so as to expose a large area, prevent drooping in calm wind, or wrapping around the cable.

c. Color Patterns. One of the following color patterns should be used:

1. Solid Color. Aviation orange.

2. Orange and White. Two triangular sections, one of aviation orange and the other white, combined to form a rectangle.

113. PURPOSE

Flashing obstruction lights should be used on moored balloons or kites and their mooring lines to warn pilots of their presence during the hours between sunset and sunrise and during periods of reduced visibility. These lights may be operated 24 hours a day.

a. Systems. Flashing red (L-864) or white beacons (L-865) may be used to light moored balloons or kites. High intensity lights (L-856) are not recommended.

b. Display. Flashing lights should be displayed on the top, nose section, tail section, and on the tether cable approximately 15 feet (4.6m) below the craft so as to define the extremes of size and shape. Additional lights should be equally spaced along the cable's overall length for each 350 feet (107m) or fraction thereof.

c. Exceptions. When the requirements of this paragraph cannot be met, floodlighting may be used.

114. OPERATIONAL CHARACTERISTICS

The light intensity is controlled by a device that changes the intensity when the ambient light changes. The system should automatically turn the lights on and change intensities as ambient light condition change. The reverse order should apply in changing from nighttime to daytime operation. The lights should flash simultaneously.

CHAPTER 12. MARKING AND LIGHTING EQUIPMENT AND INFORMATION

120. PURPOSE

This chapter lists documents relating to obstruction marking and lighting systems and where they may be obtained.

121. PAINT STANDARD

Paint and aviation colors/gloss, referred to in this publication should conform to Federal Standard FED-STD-595. Approved colors shall be formulated without the use of Lead, Zinc Chromate or other heavy metals to match International Orange, White and Yellow. All coatings shall be manufactured and labeled to meet Federal Environmental Protection Act Volatile Organic Compound(s) guidelines, including the National Volatile Organic Compound Emission Standards for architectural coatings.

a. Exterior Acrylic Waterborne Paint. Coating should be a ready mixed, 100% acrylic, exterior latex formulated for application directly to galvanized surfaces. Ferrous iron and steel or non-galvanized surfaces shall be primed with a manufacturer recommended primer compatible with the finish coat.

b. Exterior Solventborne Alkyd Based Paint. Coating should be ready mixed, alkyd-based, exterior enamel for application directly to non-galvanized surfaces such as ferrous iron and steel. Galvanized surfaces shall be primed with a manufacturer primer compatible with the finish coat.

Paint Standards Color Table

COLOR	NUMBER
Orange	12197
White	17875
Yellow	13538

TBL 3

Note-

1. Federal specification T1-P-59, aviation surface paint, ready mixed international orange.
2. Federal specification T1-102, aviation surface paint, oil titanium zinc.
3. Federal specification T1-102, aviation surface paint, oil, exterior, ready mixed, white and light tints.

122. AVAILABILITY OF SPECIFICATIONS

Federal specifications describing the technical characteristics of various paints and their application techniques may be obtained from:

GSA- Specification Branch
 470 L'Enfant Plaza
 Suite 8214
 Washington, DC 20407
 Telephone: (202) 619-8925

123. LIGHTS AND ASSOCIATED EQUIPMENT

The lighting equipment referred to in this publication should conform to the latest edition of one of the following specifications, as applicable:

a. Obstruction Lighting Equipment.

1. AC 150/5345-43, FAA Specification for Obstruction Lighting Equipment.
2. Military Specifications MIL-L-6273, Light, Navigational, Beacon, Obstacle or Code, Type G-1.
3. Military Specifications MIL-L-7830, Light Assembly, Markers, Aircraft Obstruction.

b. Certified Equipment.

1. AC 150/5345-53, Airport Lighting Certification Program, lists the manufacturers that have demonstrated compliance with the specification requirements of AC 150/5345-43.
2. Other manufacturers' equipment may be used provided that equipment meets the specification requirements of AC 150/5345-43.

c. Airport Lighting Installation and Maintenance.

1. AC 150/5340-21, Airport Miscellaneous Lighting Visual Aids, provides guidance for the installation, maintenance, testing, and inspection of obstruction lighting for airport visual aids such as airport beacons, wind cones, etc.
2. AC 150/5340-26, Maintenance of Airport Visual Aid Facilities, provides guidance on the maintenance of airport visual aid facilities.

d. Vehicles.

1. AC 150/5210-5, Painting, Marking, and Lighting of Vehicles Used on an Airport, contains provisions for marking vehicles principally used on airports.
2. FAA Facilities. Obstruction marking for FAA facilities shall conform to FAA Drawing Number D-5480, referenced in FAA Standard FAA-STD-003, Paint Systems for Structures.

124. AVAILABILITY

The standards and specifications listed above may be obtained free of charge from the below-indicated office:

a. Military Specifications:

Standardization Document Order Desk
700 Robbins Avenue
Building #4, Section D
Philadelphia, PA 19111-5094

b. FAA Specifications:

Manager, ASD-110
Department of Transportation
Document Control Center
Martin Marietta/Air Traffic Systems
475 School St., SW.
Washington, DC 20024
Telephone: (202) 646-2047
FAA Contractors Only

c. FAA Advisory Circulars:

Department of Transportation
TASC
Subsequent Distribution Office, SVC-121.23
Ardmore East Business Center
3341 Q 75th Avenue
Landover, MD 20785
Telephone: (301) 322-4961

CHAPTER 13. MARKING AND LIGHTING WIND TURBINE FARMS

130. PURPOSE

This chapter provides guidelines for the marking and lighting of wind turbine farms. For the purposes of this advisory circular, wind turbine farms are defined as a wind turbine development that contains more than three (3) turbines of heights over 200 feet above ground level. The recommended marking and lighting of these structures is intended to provide day and night conspicuity and to assist pilots in identifying and avoiding these obstacles.

131. GENERAL STANDARDS

The development of wind turbine farms is a very dynamic process, which constantly changes based on the differing terrain they are built on. Each wind turbine farm is unique; therefore it is important to work closely with the sponsor to determine a lighting scheme that provides for the safety of air traffic. The following are guidelines that are recommended for wind turbine farms. Consider the proximity to airports and VFR routes, extreme terrain where heights may widely vary, and local flight activity when making the recommendation.

a. Not all wind turbine units within an installation or farm need to be lighted. Definition of the periphery of the installation is essential; however, lighting of interior wind turbines is of lesser importance unless they are taller than the peripheral units.

b. Obstruction lights within a group of wind turbines should have unlighted separations or gaps of no more than ½ statute mile if the integrity of the group appearance is to be maintained. This is especially critical if the arrangement of objects is essentially linear.

c. Any array of flashing or pulsed obstruction lighting should be synchronized or flash simultaneously.

d. Nighttime wind turbine obstruction lighting should consist of the preferred FAA L-864 aviation red-colored flashing lights.

e. White strobe fixtures (FAA L-865) may be used in lieu of the preferred L-864 red flashing lights, but must be used alone without any red lights, and must be positioned in the same manner as the red flashing lights.

f. The white paint most often found on wind turbine units is the most effective daytime early warning device. Other colors, such as light gray or blue, appear to be significantly less effective in

providing daytime warning. Daytime lighting of wind turbine farms is not required, as long as the turbine structures are painted in a bright white color or light off-white color most often found on wind turbines.

132. WIND TURBINE CONFIGURATIONS – Prior to recommending marking and lighting, determine the configuration and the terrain of the wind turbine farm. The following is a description of the most common configurations.

a. Linear – wind turbine farms in a line-like arrangement, often located along a ridge line, the face of a mountain or along borders of a mesa or field. The line may be ragged in shape or be periodically broke, and may vary in size from just a few turbines up to 20 miles long.

b. Cluster – turbine farms where the turbines are placed in circles like groups on top of a mesa, or within a large field. A cluster is typically characterized by having a pronounced perimeter, with various turbines placed inside the circle at various, erratic distances throughout the center of the circle.

c. Grid – turbine farms arranged in a geographical shape such as a square or a rectangle, where each turbine is set a consistent distance from each other in rows, giving the appearance that they are part of a square like pattern.

133. MARKING STANDARDS

The bright white or light off-white paint most often found on wind turbines has been shown to be most effective, and if used, no lights are required during the daytime. However, if darker paint is used, wind turbine marking should be supplemented with daytime lighting, as required.

134. LIGHTING STANDARDS

a. Flashing red (L864), or white (L-865) lights may be used to light wind turbines. Studies have shown that red lights are most effective, and should be the first consideration for lighting recommendations of wind turbines.

b. Obstruction lights should have unlighted separations or gaps of no more than ½ mile. Lights should flash simultaneously. Should the synchronization of the lighting system fail, a lighting outage report should be made in accordance with paragraph 23 of this advisory circular. Light fixtures should be placed as high as possible on the turbine nacelle, so as to be visible from 360 degrees.

c. Linear Turbine Configuration. Place a light on each turbine positioned at each end of the line or string of turbines. Lights should be no more than $\frac{1}{2}$ statute mile, or 2640 feet from the last lit turbine. In the event the last segment is significantly short, push the lit turbines back towards the starting point to present a well balanced string of lights. High concentrations of lights should be avoided.

d. Cluster Turbine Configuration. Select a starting point among the outer perimeter of the cluster. This turbine should be lit, and a light should be placed on the next turbine so that no more than a $\frac{1}{2}$ statute mile gap exists. Continue this pattern around the perimeter. If the distance across the cluster is greater than 1 mile, and/or the terrain varies by more than 100 feet, place one or more lit turbines at locations throughout the center of the cluster.

e. Grid Turbine Configuration. Select each of the defined corners of the layout to be lit, and then utilize the same concept of the cluster configuration as outlined in paragraph d.

f. Special Considerations. On occasion, one or two turbines may be located apart from the main grouping of turbines. If one or two turbines protrude from the general limits of the turbine farm, these turbines should be lit.

APPENDIX 1: Specifications for Obstruction Lighting Equipment Classification
APPENDIX

Type	Description
L-810	Steady-burning Red Obstruction Light
L-856	High Intensity Flashing White Obstruction Light (40 FPM)
L-857	High Intensity Flashing White Obstruction Light (60 FPM)
L-864	Flashing Red Obstruction Light (20-40 FPM)
L-865	Medium Intensity Flashing White Obstruction Light (40-FPM)
L-866	Medium Intensity Flashing White Obstruction Light (60-FPM)
L-864/L-865	Dual: Flashing Red Obstruction Light (20-40 FPM) and Medium Intensity Flashing White Obstruction Light (40 FPM)
L-885	Red Catenary 60 FPM
FPM = Flashes Per Minute	

TBL 4

PAINING AND/OR DUAL LIGHTING OF CHIMNEYS, POLES, TOWERS, AND SIMILAR STRUCTURES

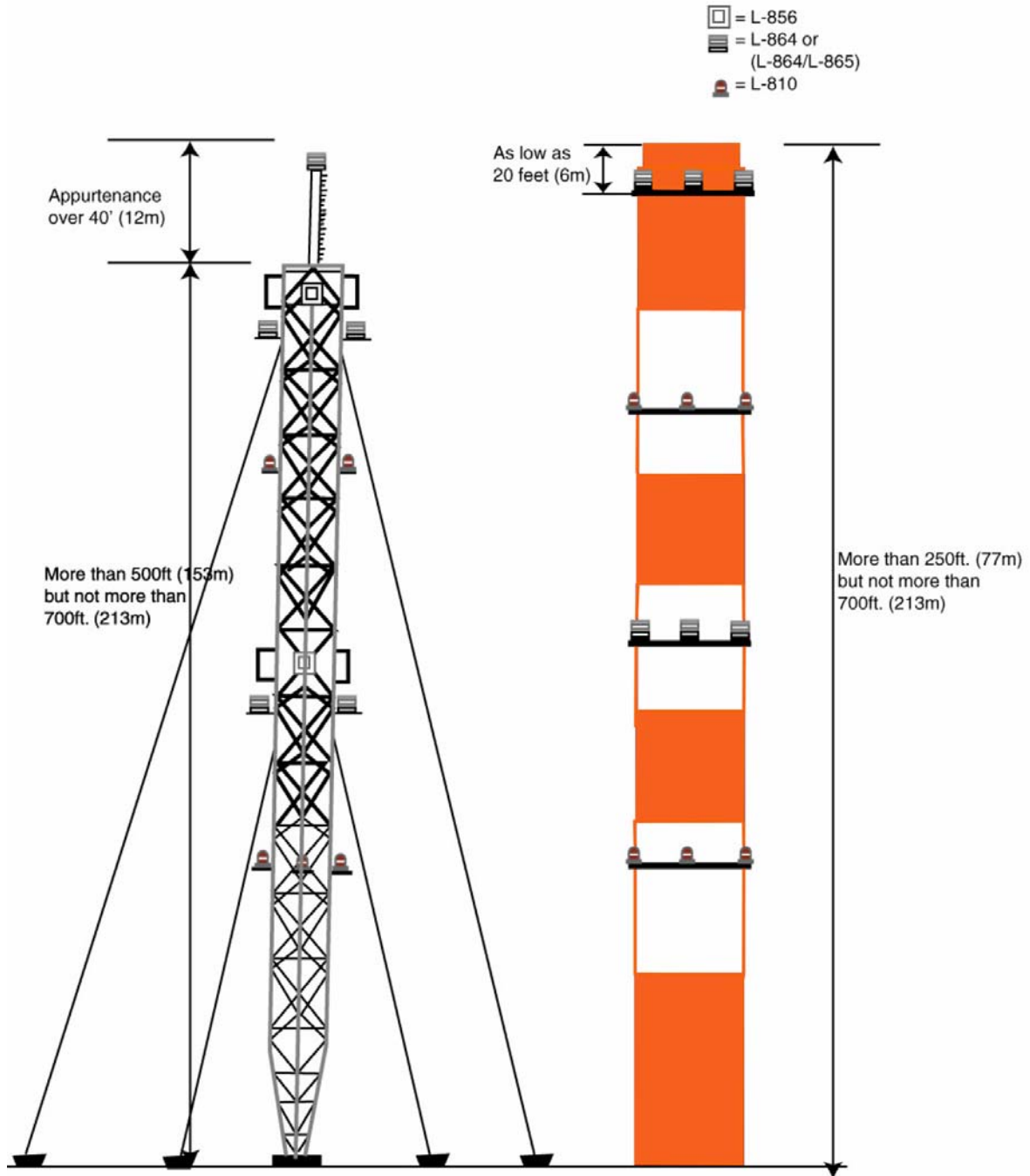
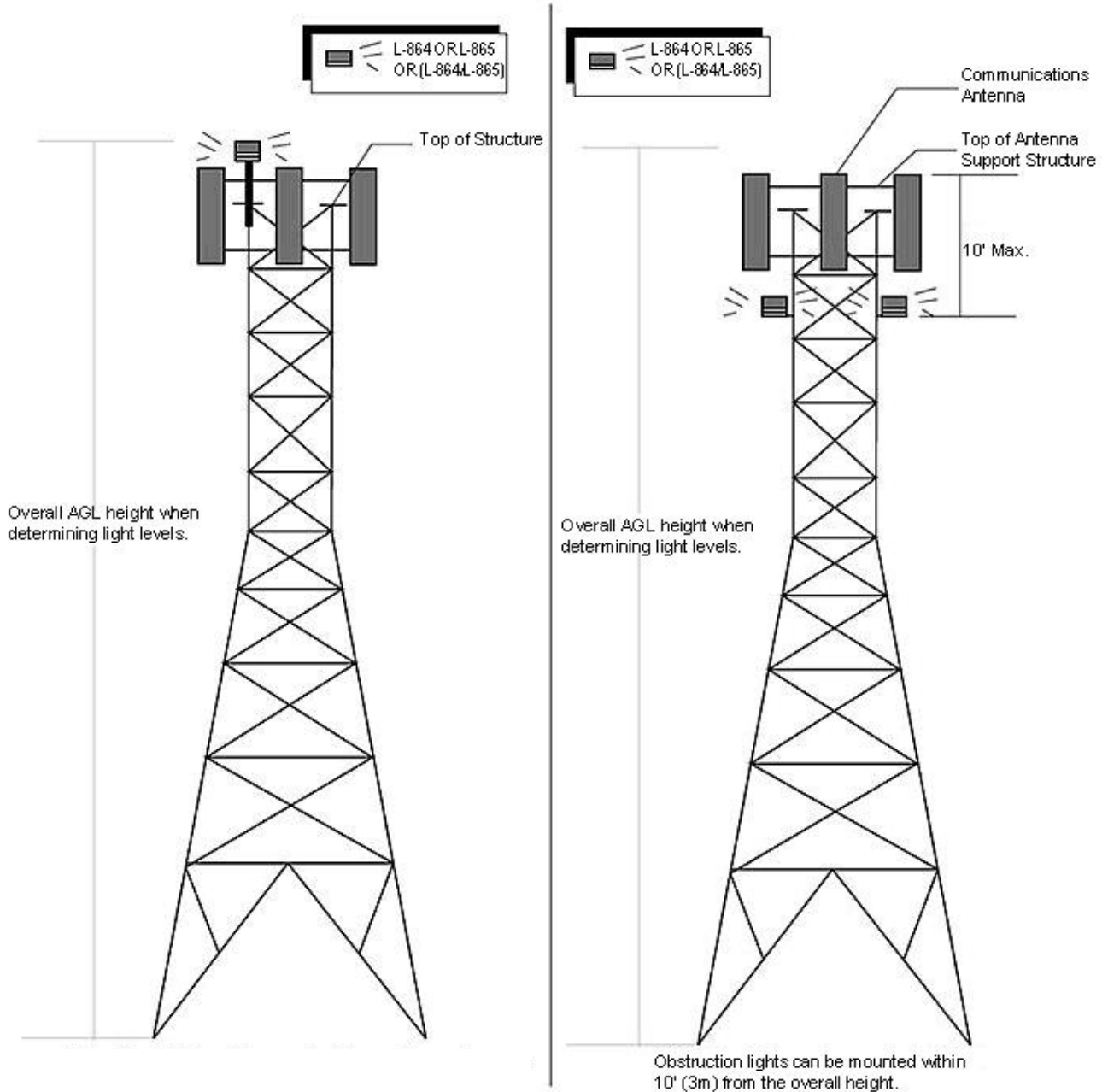

FIG 1



Intermediate lighting not shown. Overall AGL height if more than 200' (61m), but not more than 500' (153m).

FIG 2

PAINTING AND LIGHTING OF WATER TOWERS, STORAGE TANKS, AND SIMILAR STRUCTURES

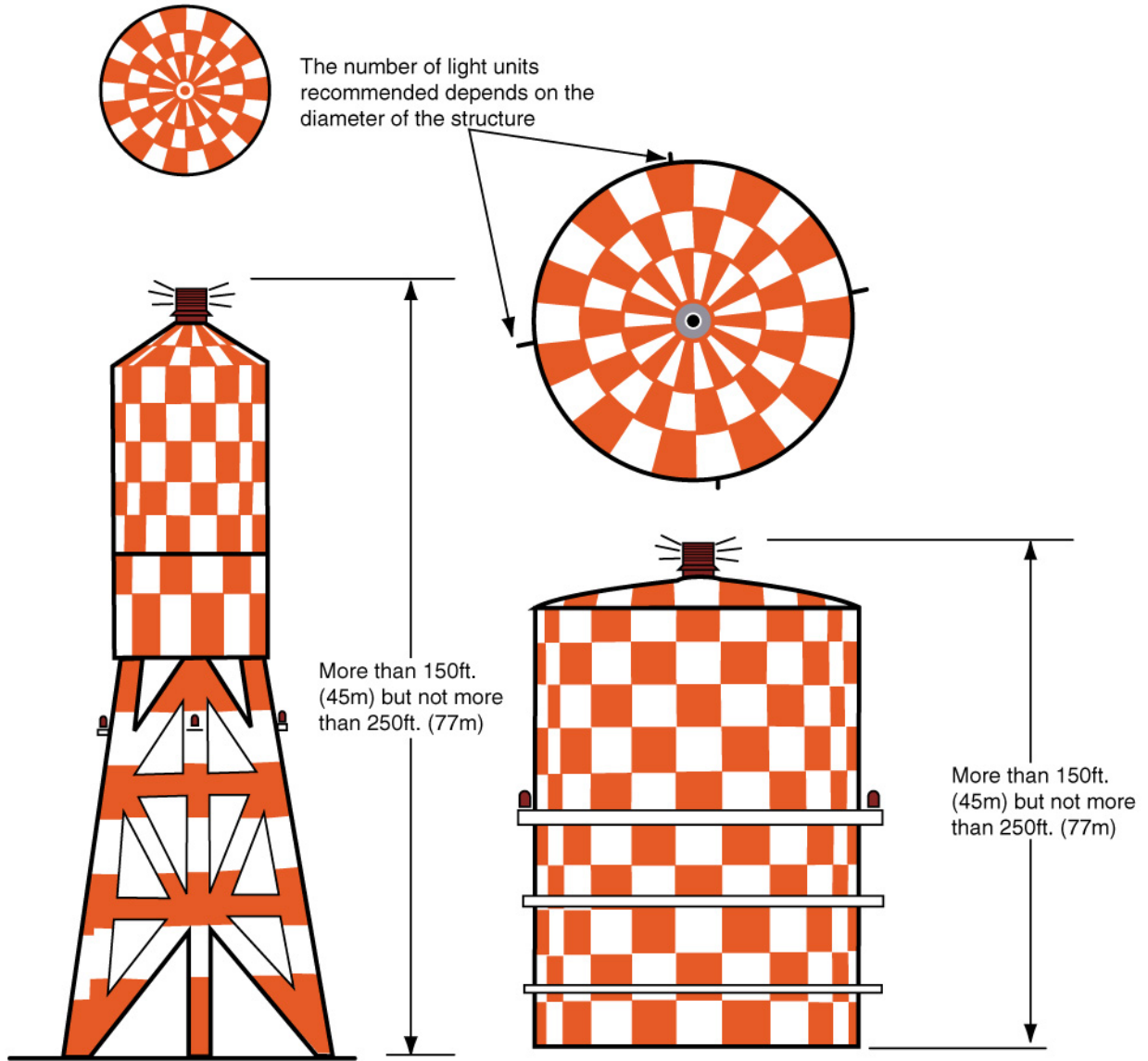

FIG 3

PAINING AND LIGHTING OF WATER TOWERS ANDE SIMILAR STRUCTURES

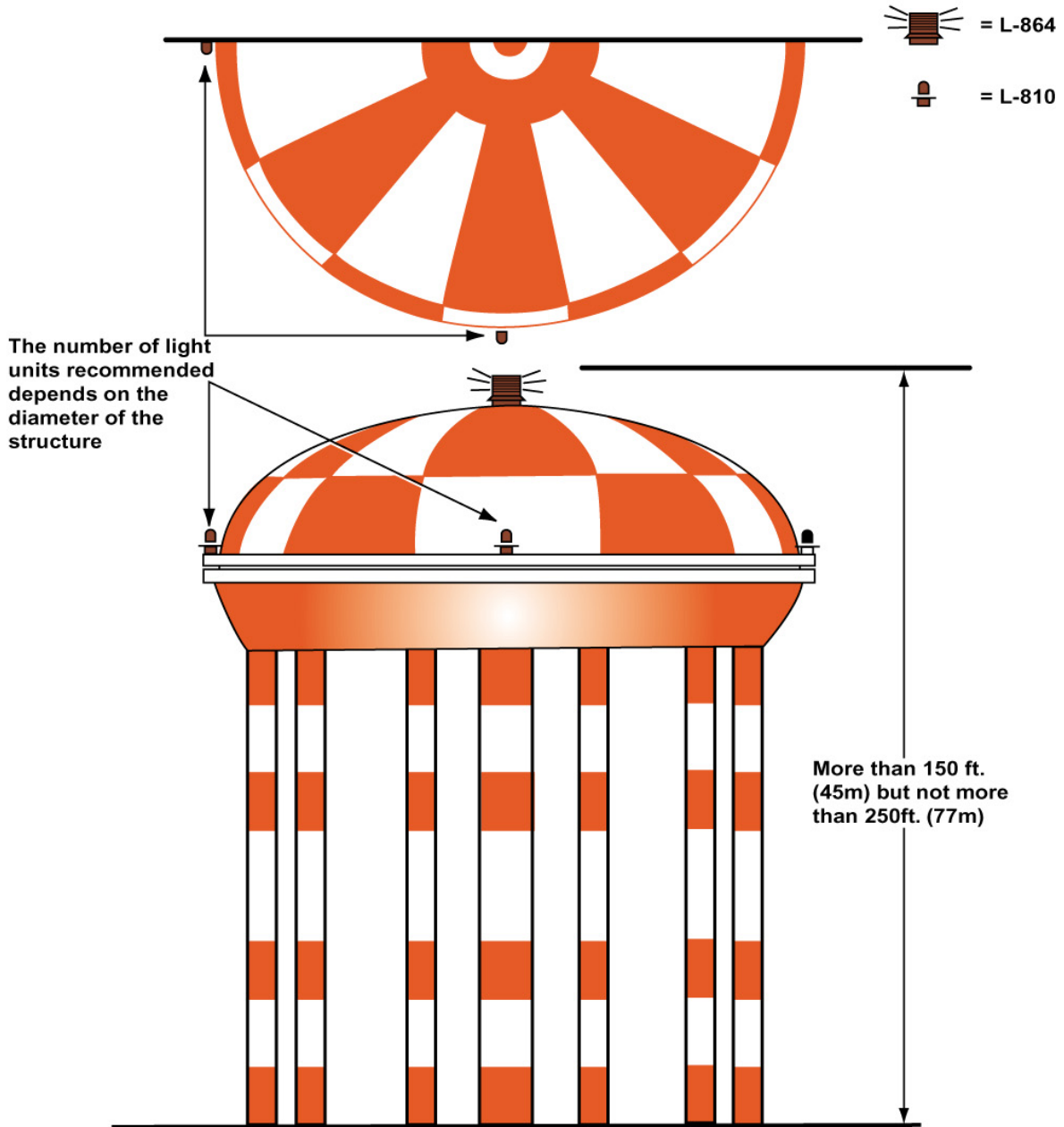

FIG 4

PAINING OF SINGLE PEDESTAL WATER TOWER BY TEARDROP PATTERN

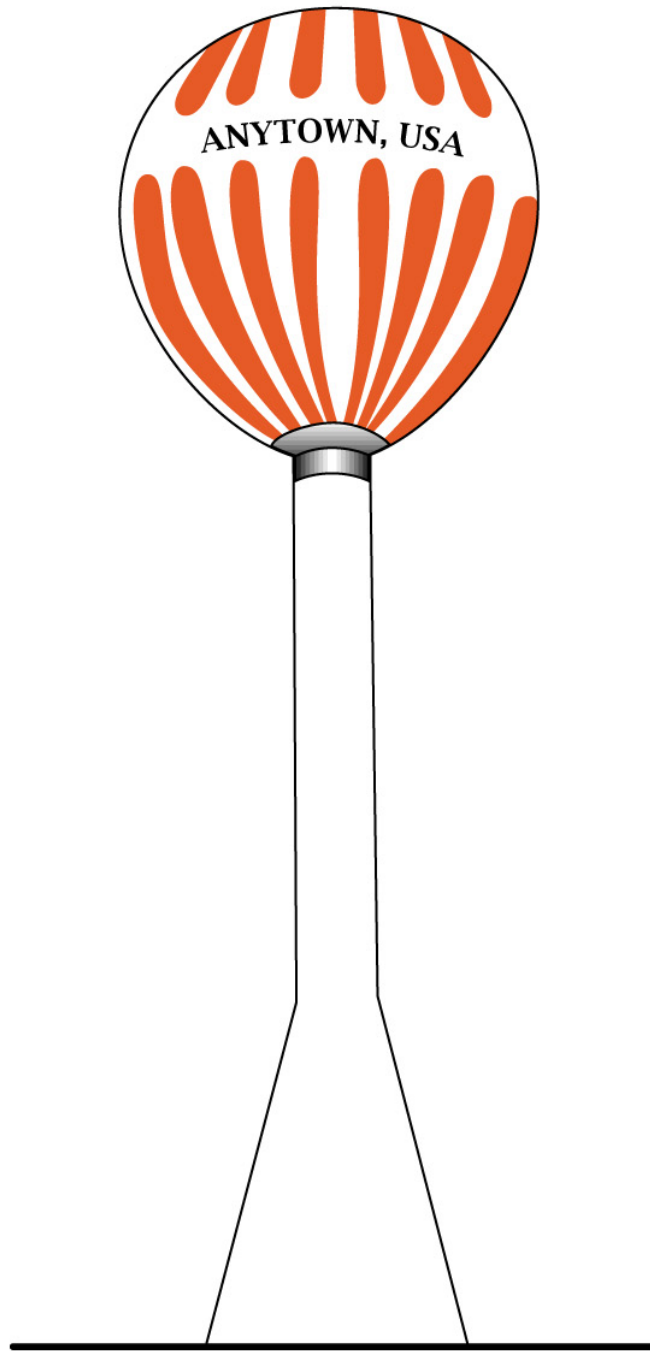
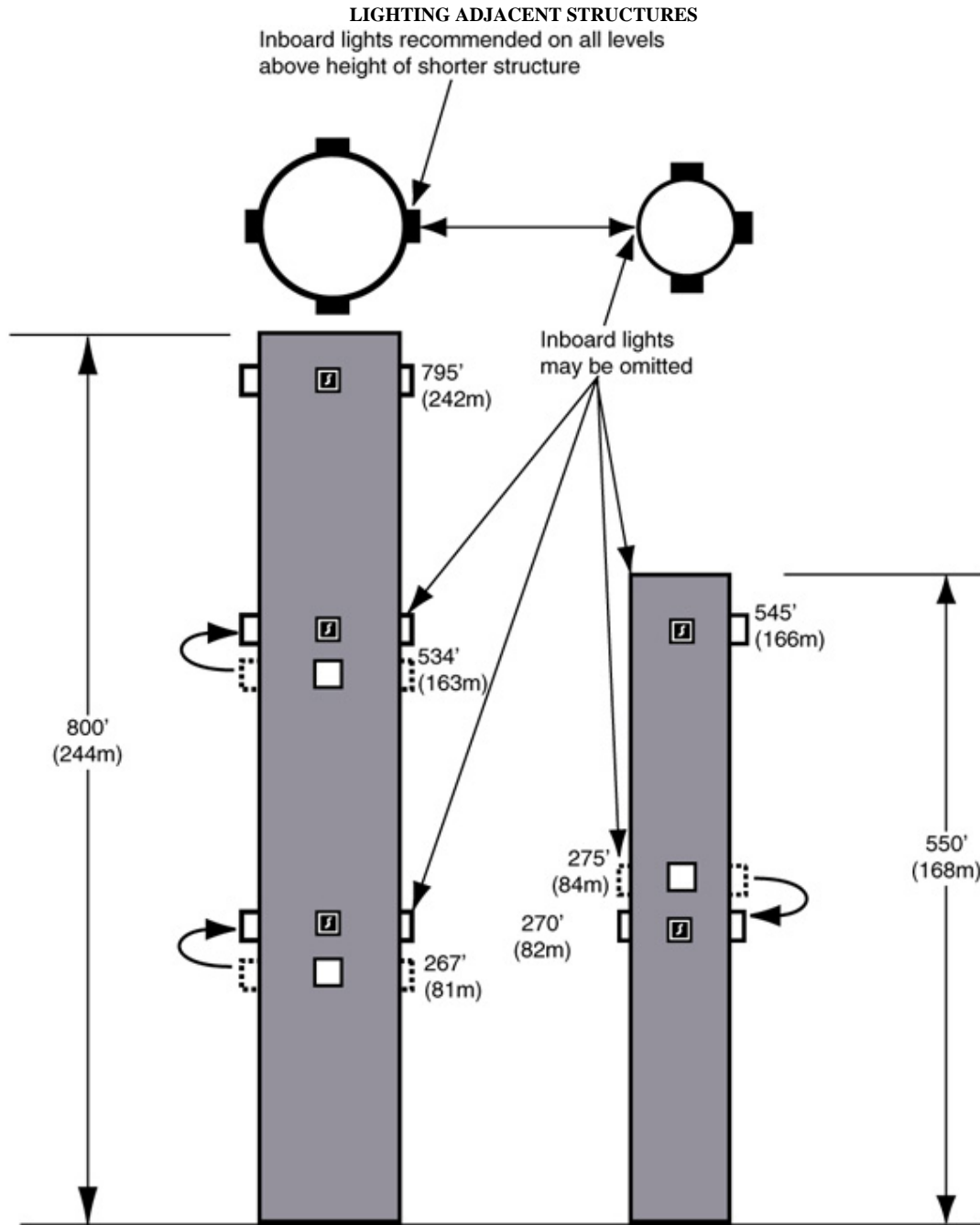

FIG 5



Minor adjustments in vertical placement may be made to place lights on same horizontal plane. Lights on both structures be synchronized

FIG 6

Lighting Adjacent Structure

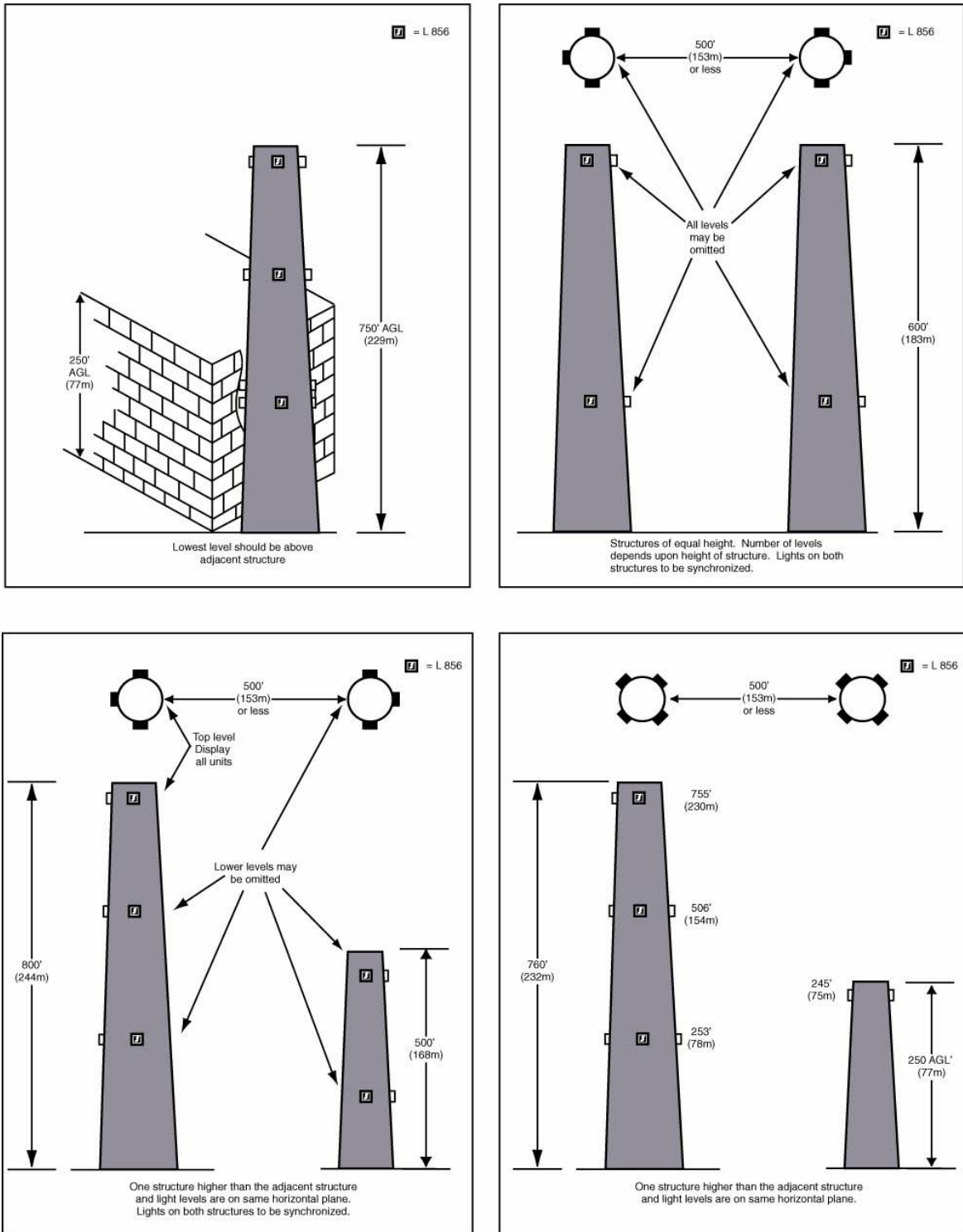

FIG 7

Lighting Adjacent Structure

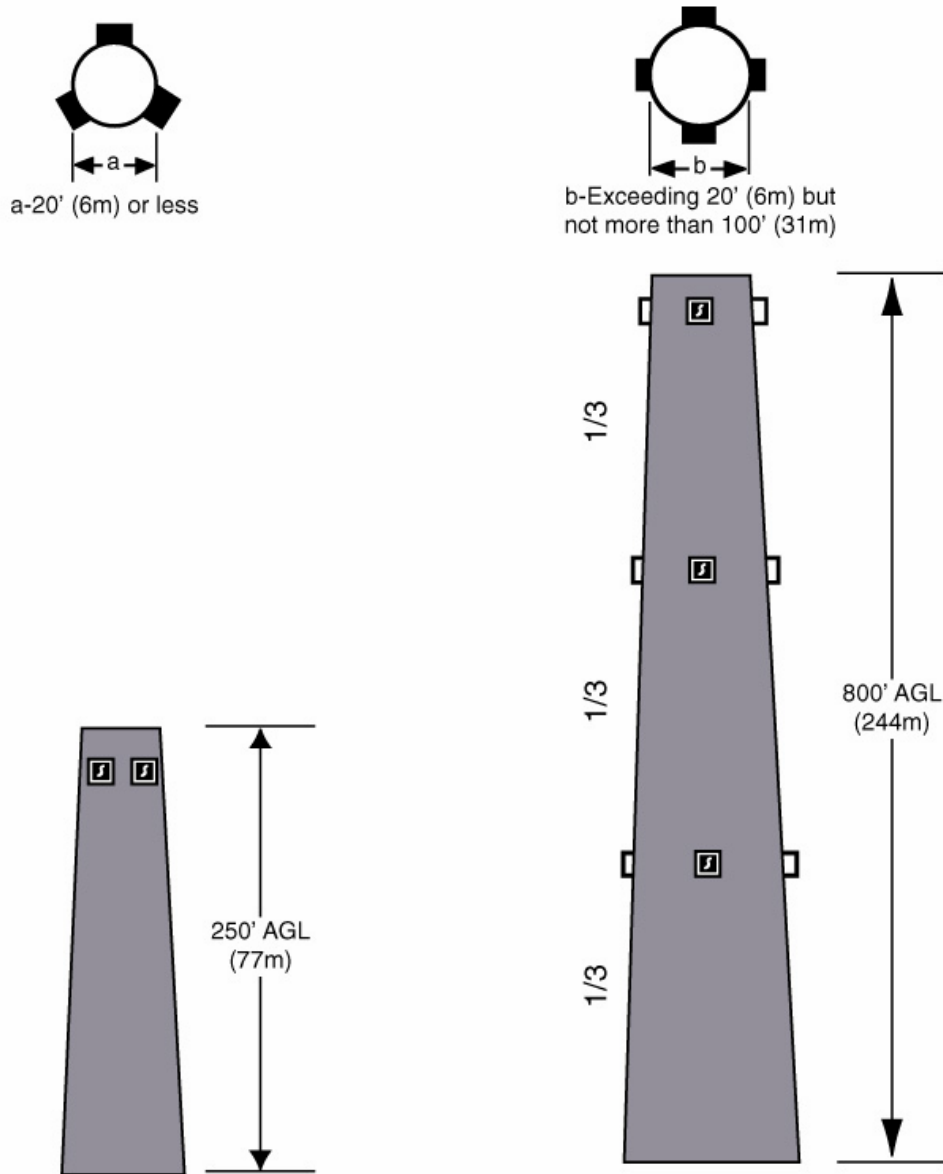

FIG 8

HYPERBOLIC COOLING TOWER

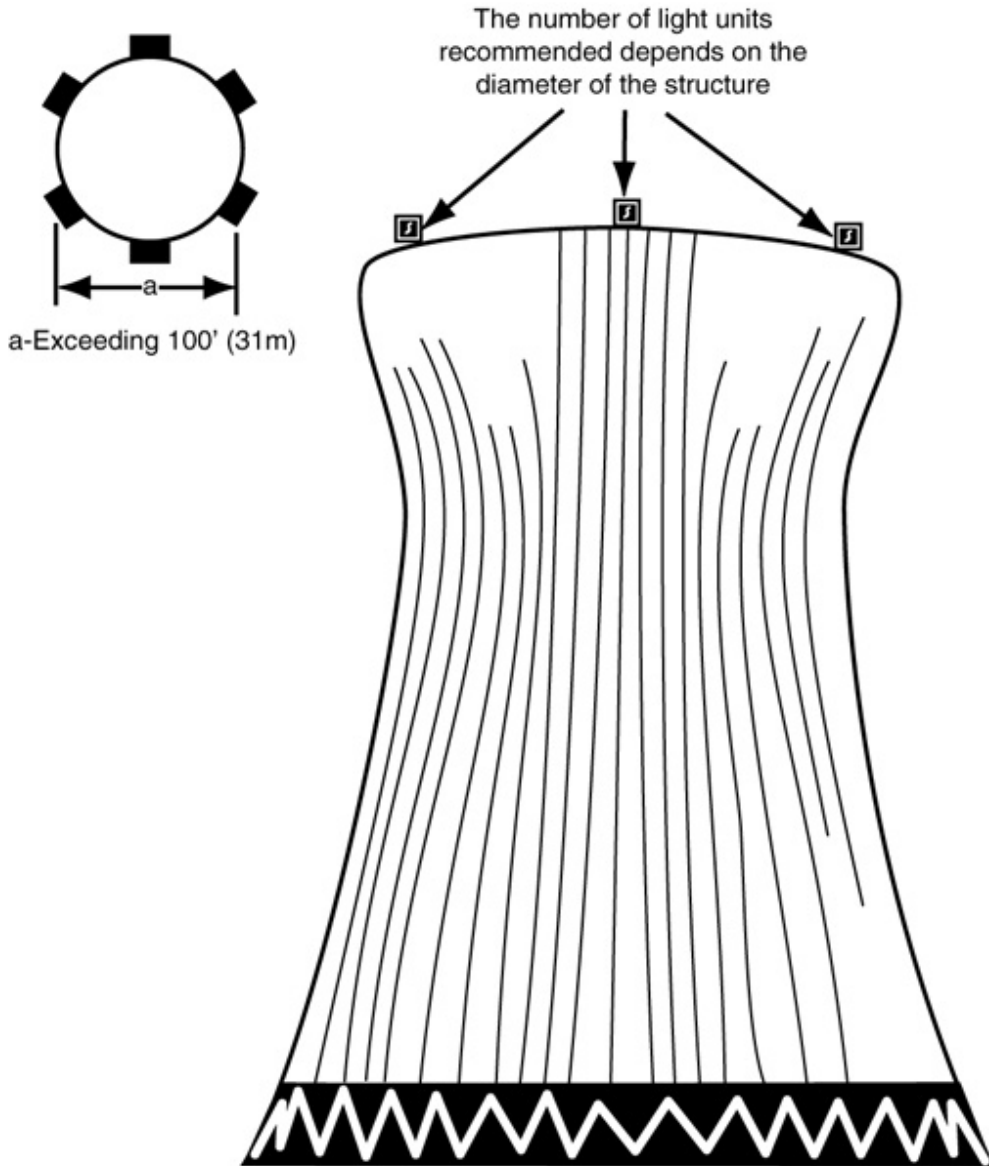

FIG 9

BRIDGE LIGHTING

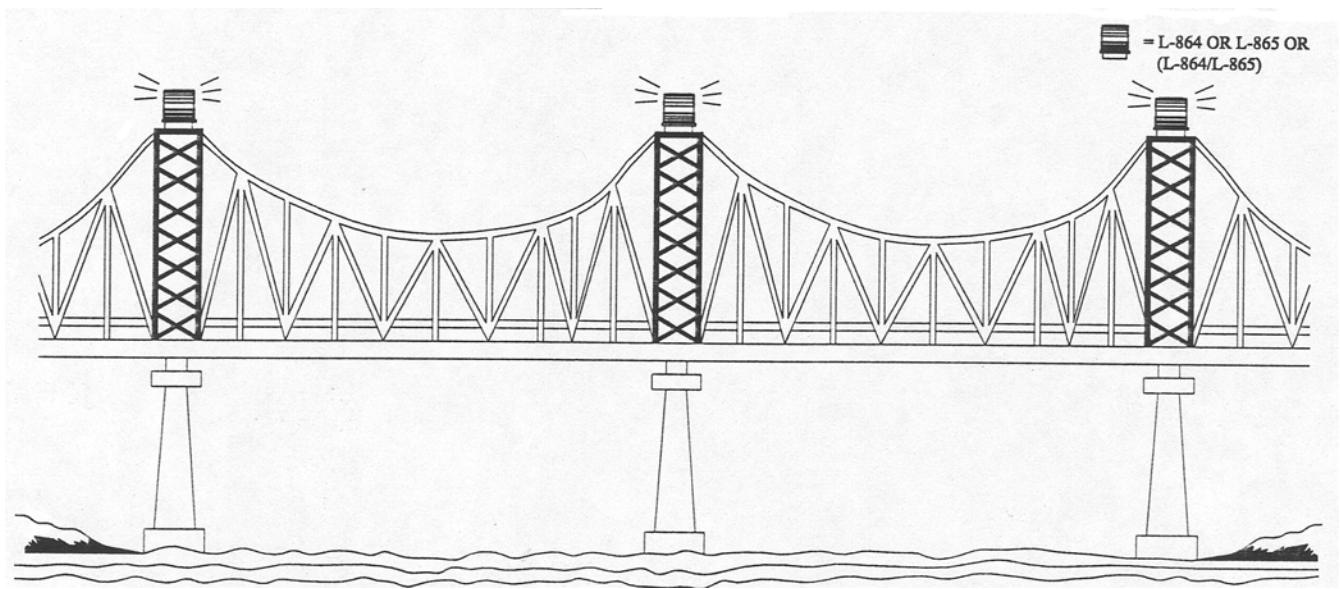
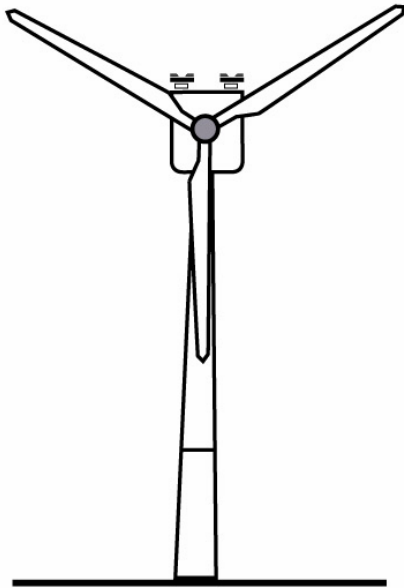
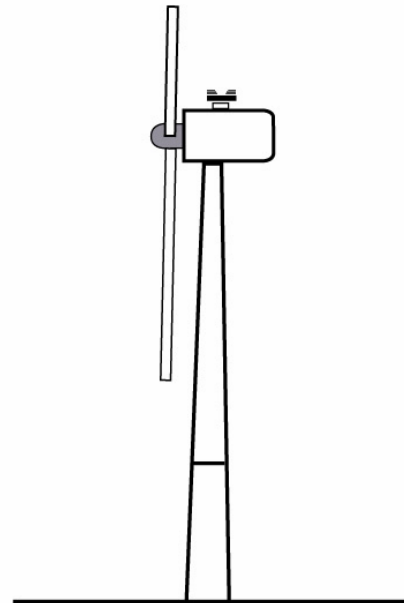

FIG 10

TYPICAL LIGHTING OF A STAND ALONE WIND TURBINE



Front View



Side View

FIG 11

WIND TURBINE GENERATOR

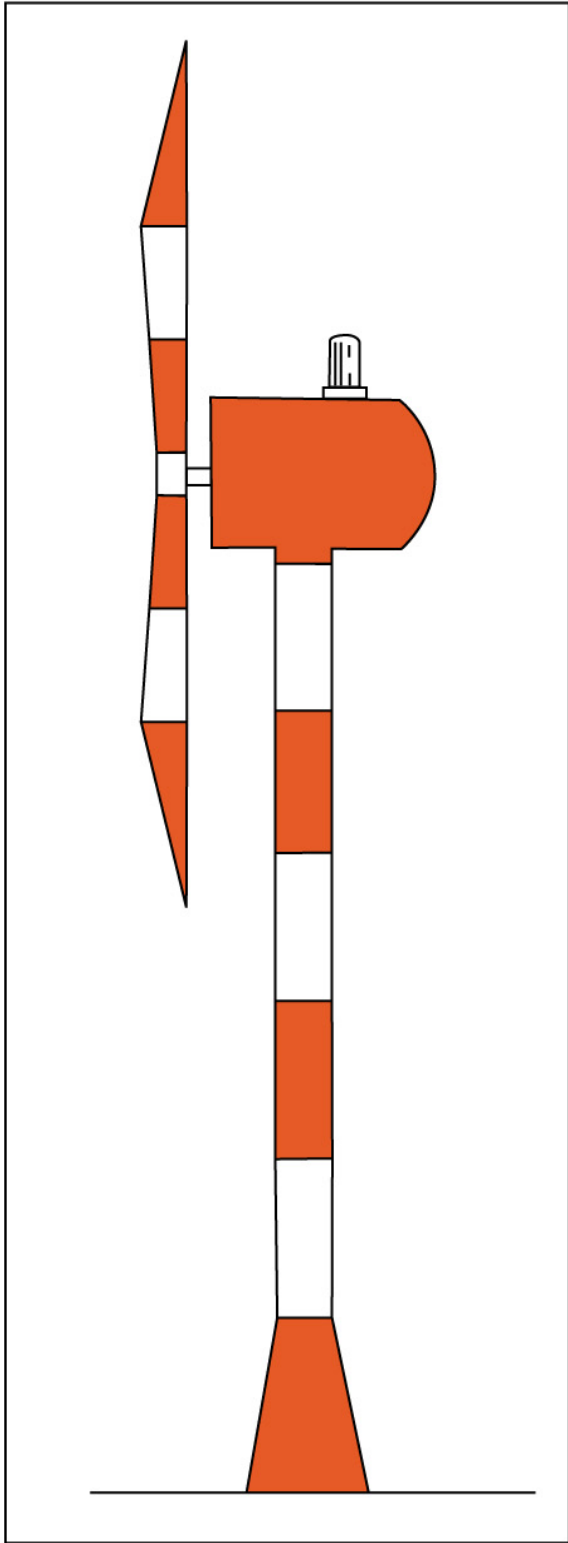
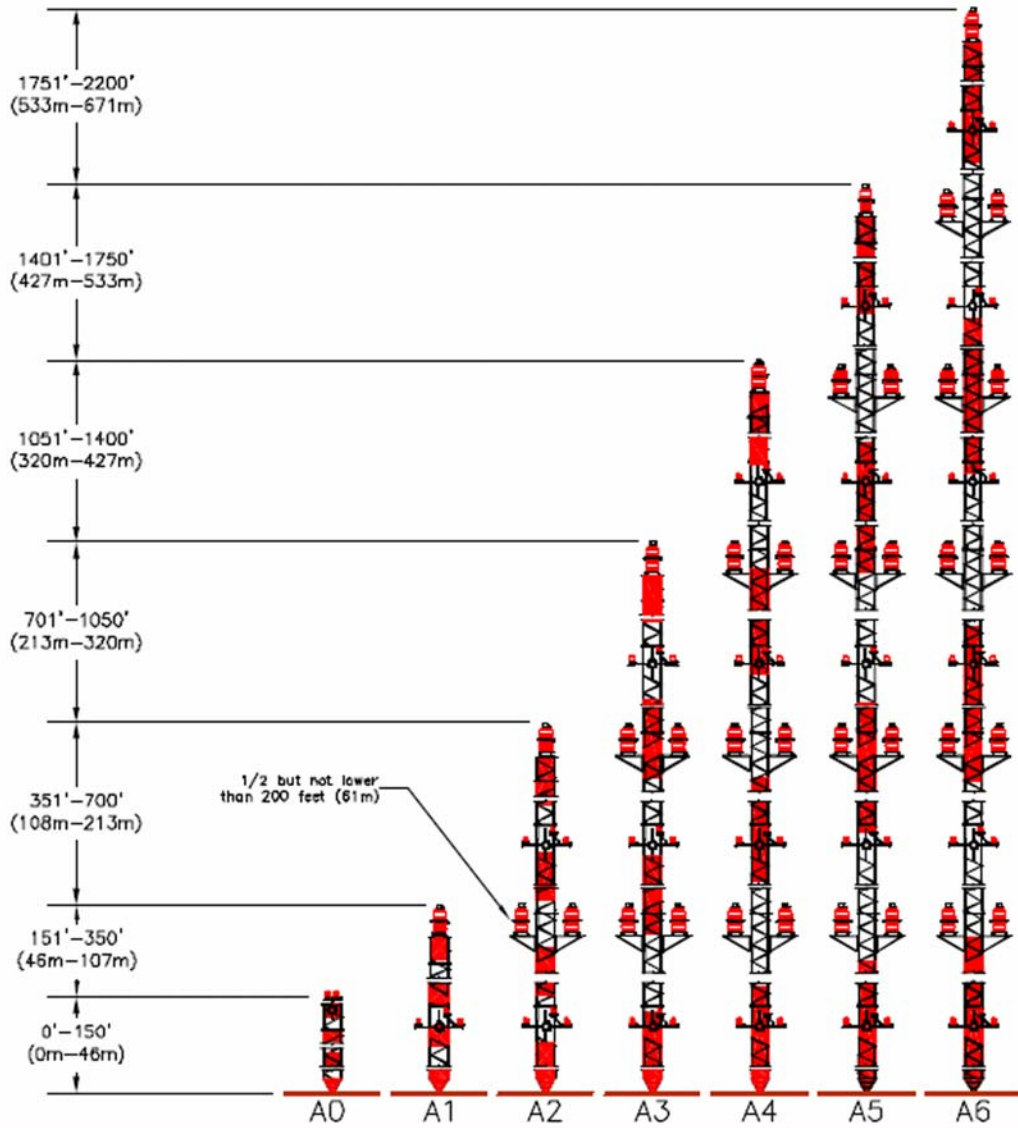

FIG 12

RED OBSTRUCTION LIGHTING STANDARDS (FAA Style A)

Day Protection = Aviation Orange/White Paint
Night Protection = 2,000cd Red Beacon and sidelights



– L-864 Flashing Beacon



– L-810 Obstruction Light

FIG 13

MEDIUM INTENSITY WHITE OBSTRUCTION LIGHTING STANDARDS (FAA Style D)

Day/Twilight Protection = 20,000cd White Strobe
Night Protection = 2,000cd White Strobe
Painting of tower is typically not required.

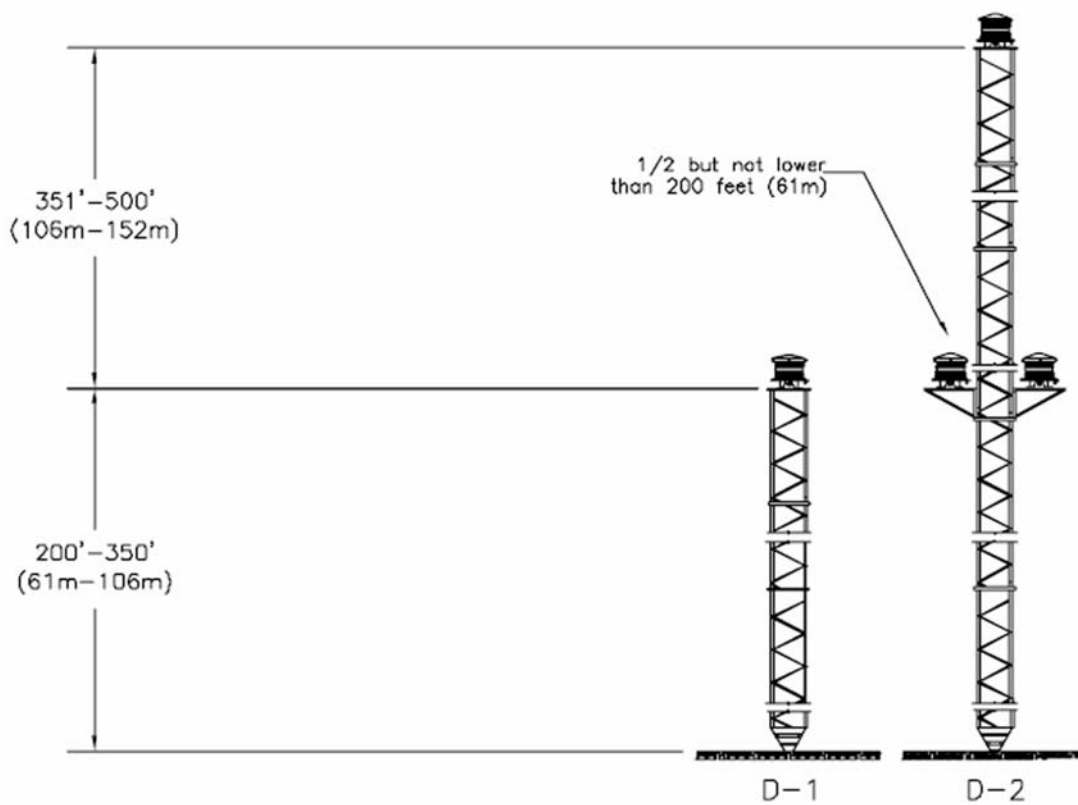

FIG 14

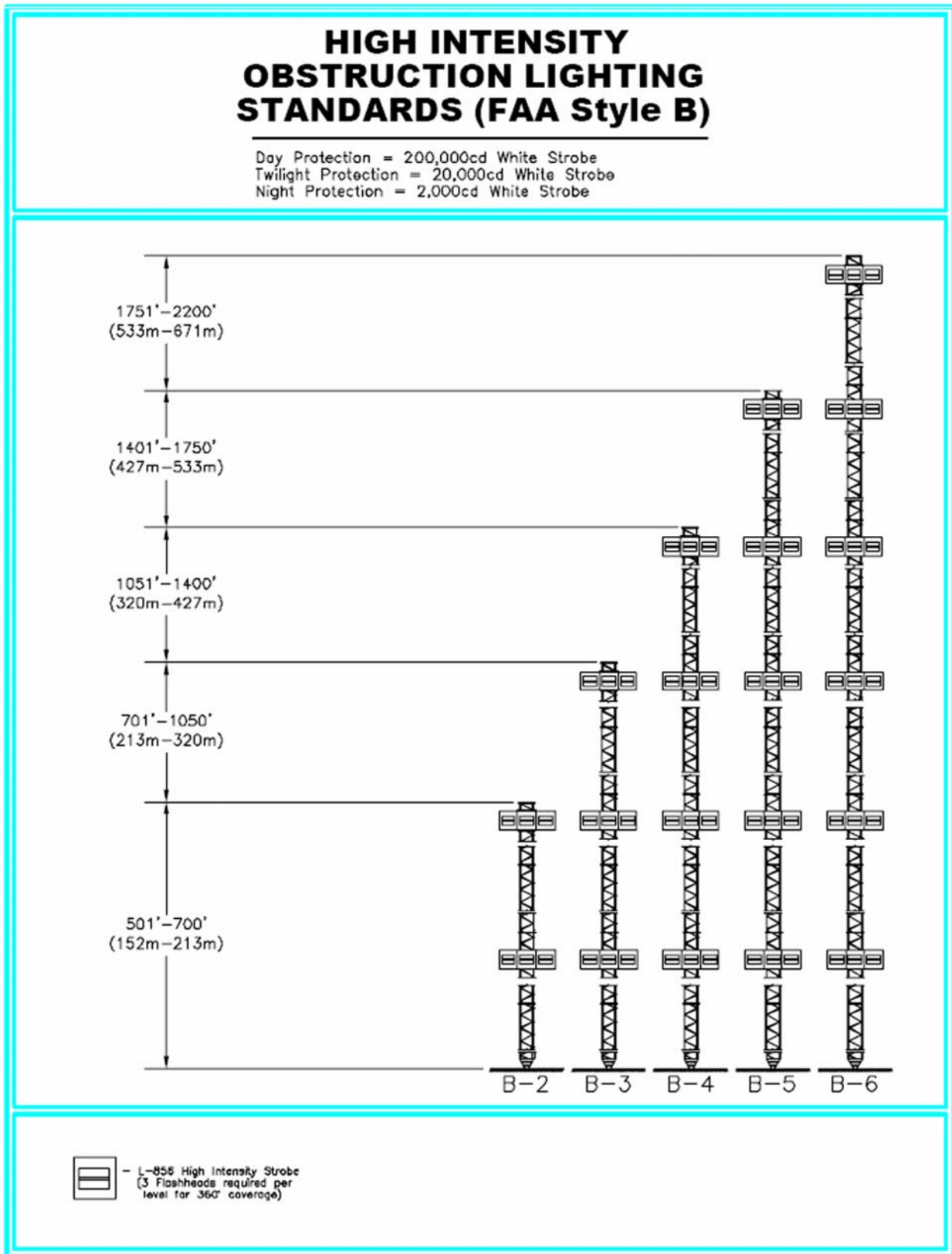

FIG 15

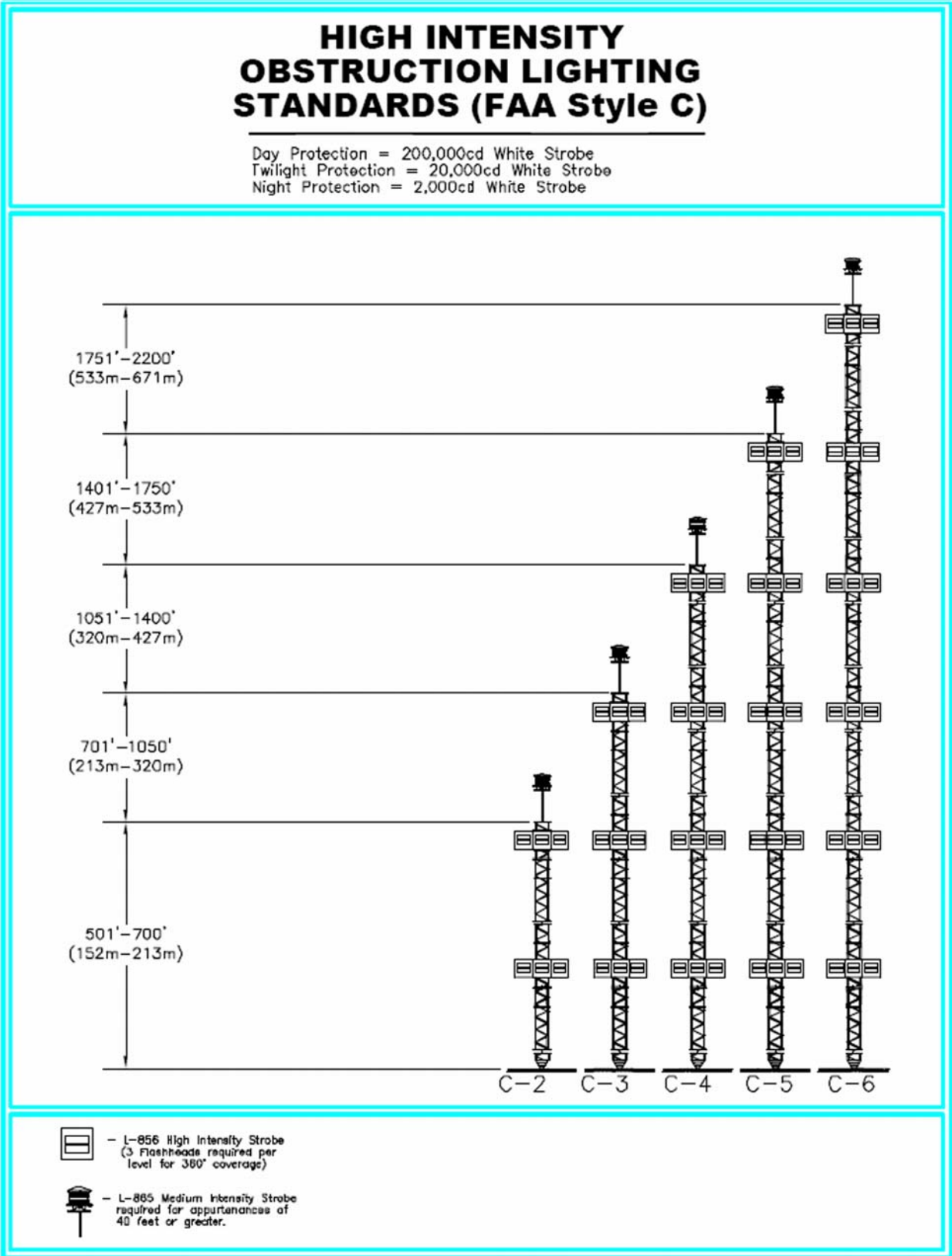
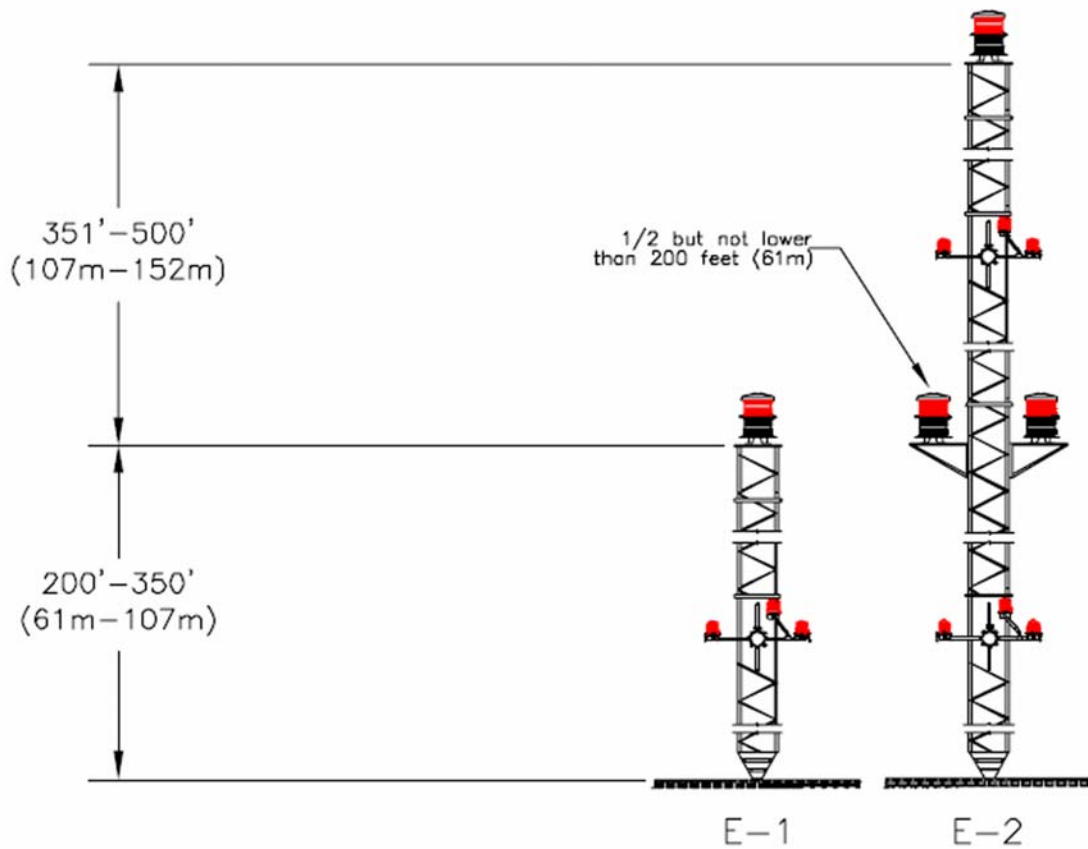

FIG 16

MEDIUM INTENSITY DUAL OBSTRUCTION LIGHTING STANDARDS (FAA Style E)

Day/Twilight Protection = 20,000cd White Strobe
Night Protection = 2,000cd Red Strobe and sidelights
Painting of tower is typically not required.





-  - L-864/L-865 Flashing Dual (White/Red) Strobe
-  - L-810 Obstruction Light

FIG 17

DUAL HIGH INTENSITY OBSTRUCTION LIGHTING STANDARDS (FAA Style F)

Day Protection = 200,000cd White Strobe
Twilight Protection = 20,000cd White Strobe
Night Protection = 2,000cd Red Beacon and sidelights



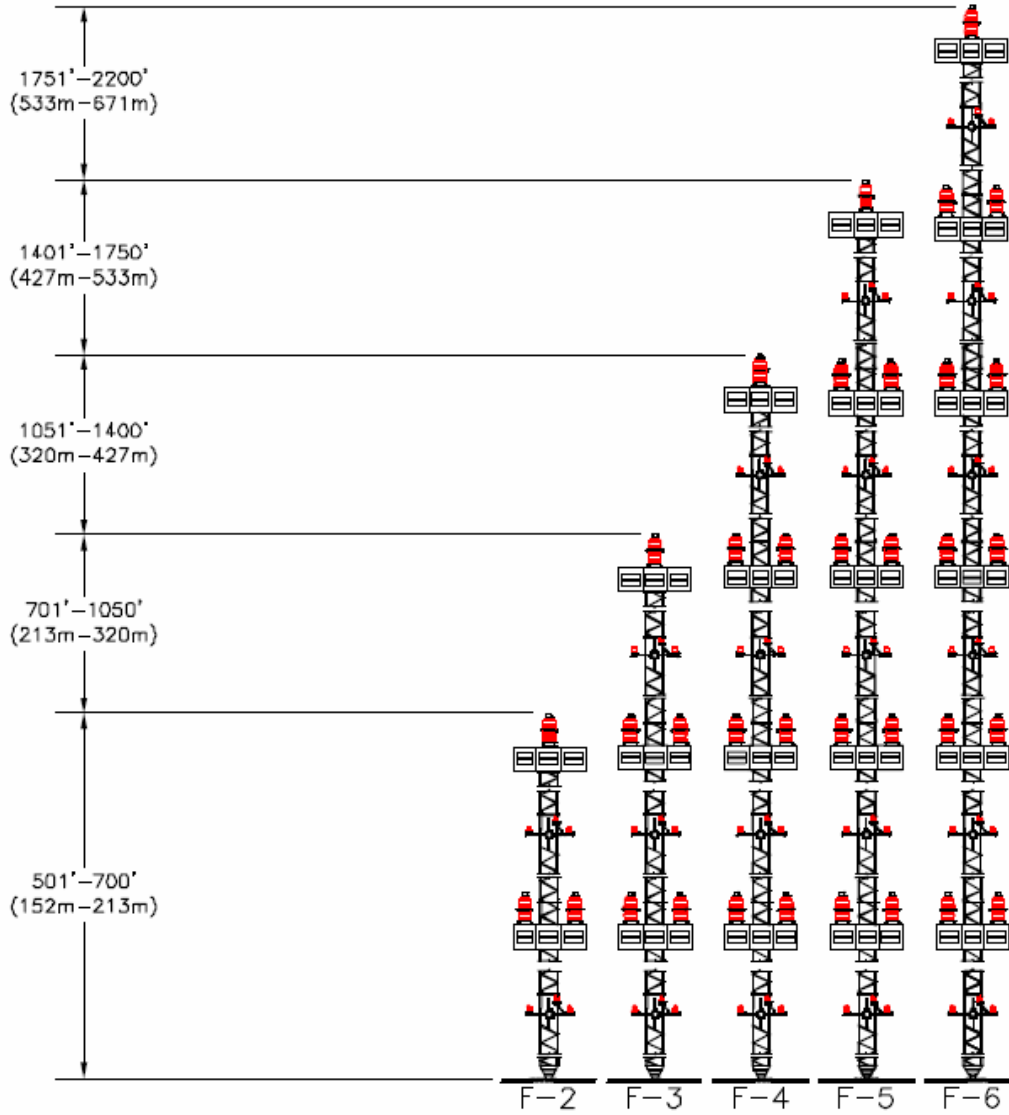

-  - L-B54 Flashing Beacon
-  - L-B10 Obstruction Light
-  - L-B58 High Intensity Strobe (3 Flashheads required per level for 360° coverage)

FIG 18

APPENDIX 2. Miscellaneous

1. RATIONALE FOR OBSTRUCTION LIGHT INTENSITIES.

Sections 91.117, 91.119 and 91.155 of the FAR Part 91, General Operating and Flight Rules, prescribe aircraft speed restrictions, minimum safe altitudes, and basic visual flight rules (VFR) weather minimums for

governing the operation of aircraft, including helicopters, within the United States.

2. DISTANCE VERSUS INTENSITIES.

TBL 5 depicts the distance the various intensities can be seen under 1 and 3 statute miles meteorological visibilities:

Distance/Intensity Table

<i>Time Period</i>	<i>Meteorological Visibility Statute Miles</i>	<i>Distance Statute Miles</i>	<i>Intensity Candelas</i>
Night		2.9 (4.7km)	1,500 (+/- 25%)
	3 (4.8km)	3.1 (4.9km)	2,000 (+/- 25%)
		1.4 (2.2km)	32
Day		1.5 (2.4km)	200,000
	1 (1.6km)	1.4 (2.2km)	100,000
		1.0 (1.6km)	20,000 (+/- 25%)
Day		3.0 (4.8km)	200,000
	3 (4.8km)	2.7 (4.3km)	100,000
		1.8 (2.9km)	20,000 (+/- 25%)
Twilight	1 (1.6km)	1.0 (1.6km) to 1.5 (2.4km)	20,000 (+/- 25%)?
Twilight	3 (4.8km)	1.8 (2.9km) to 4.2 (6.7km)	20,000 (+/- 25%)?

Note-

1. DISTANCE CALCULATED FOR NORTH SKY ILLUMINANCE.

TBL 5

3. CONCLUSION.

Pilots of aircraft travelling at 165 knots (190 mph/306kph) or less should be able to see obstruction lights in sufficient time to avoid the structure by at least 2,000 feet (610m) horizontally under all conditions of operation, provided the pilot is operating in accordance with FAR Part 91. Pilots operating between 165 knots (190 mph/303 km/h) and 250 knots (288 mph/463 kph) should be able to see the obstruction lights unless the weather deteriorates to 3 statute miles (4.8 kilometers) visibility at night, during which time period 2,000 candelas would be required to see the lights at 1.2 statute miles (1.9km). A higher intensity, with 3 statute miles (4.8 kilometers) visibility at night, could generate a residential annoyance factor. In addition, aircraft in these speed ranges can normally be expected to operate under instrument flight rules (IFR) at night when the visibility is 1 statute mile (1.6 kilometers).

4. DEFINITIONS.

a. Flight Visibility. The average forward horizontal distance, from the cockpit of an aircraft in flight, at which prominent unlighted objects may be seen and identified by day and prominent lighted objects may be seen and identified by night.

Reference-

AIRMAN'S INFORMATION MANUAL
PILOT/CONTROLLER GLOSSARY.

b. Meteorological Visibility. A term that denotes the greatest distance, expressed in statute miles, that selected objects (visibility markers) or lights of moderate intensity (25 candelas) can be seen and identified under specified conditions of observation.

5. LIGHTING SYSTEM CONFIGURATION.

- a. *Configuration A.* Red lighting system.
- b. *Configuration B.* High Intensity White Obstruction Lights (including appurtenance lighting).
- c. *Configuration C.* Dual Lighting System - High Intensity White & Red (including appurtenance lighting).

d. *Configuration D.* Medium Intensity White Lights (including appurtenance lighting).

e. *Configuration E.* Dual Lighting Systems - Medium Intensity White & Red (including appurtenance lighting).

Example-

“CONFIGURATION B 3” DENOTES A HIGH INTENSITY LIGHTING SYSTEM WITH THREE LEVELS OF LIGHT.